

### Buck Chopper with Field Stop Trench IGBT + SiC SBD

$V_{CES} = 600V$   
 $I_C = 60A @ T_C = 100^{\circ}C$

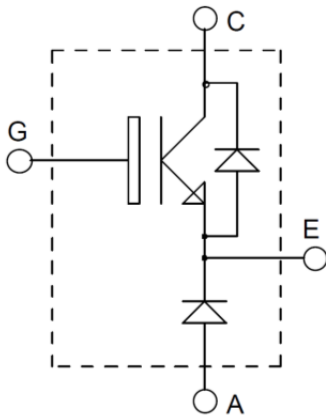


#### Features

- **Field StopTrench Fast IGBT**
  - Low voltage drop
  - Low tail current
  - Switching frequency up to 50 kHz
  - Low leakage current
- **Chopper SiC Schottky Diode**
  - Zero reverse recovery current
  - Temperature Independent switching behavior
  - Positive temperature coefficient on VF

#### Applications

- Solar inverters
- AC and DC motor control
- Power Factor Correction
- Aerospace Actuators



#### Benefits

- Outstanding performance at high frequency operation
- Low switching losses
- Very rugged
- Direct mounting to heatsink (isolated package)
- Low junction to case thermal resistance
- Easy paralleling due to positive  $T_C$  of  $V_{CESat}$
- RoHS Compliant

#### Absolute Maximum Ratings ( $T_j=25^{\circ}C$ unless otherwise specified)

Parameters	Symbol	Conditions	Specifications	Units
Collector - Emitter Breakdown Voltage	$V_{CES}$		600	V
Continuous Collector Current	$I_C$	$T_C = 25^{\circ}C$	120	A
		$T_C = 100^{\circ}C$	60	A
Gate-Emitter Voltage	$V_{GES}$		$\pm 20$	V
Pulsed Collector Current	ICM		180	A
Maximum Power Dissipation	$P_D$	$T_C = 25^{\circ}C$	312	W
		$T_C = 100^{\circ}C$	138	W
Operating Junction Temperature	$T_j$		-55 ~ 150	$^{\circ}C$
Storage Temperature	$T_{STG}$		-55 ~ 150	$^{\circ}C$

### Electrical Characteristics (T<sub>J</sub>=25°C unless otherwise specified)

Parameters	Symbol	Conditions	Min	Typ	Max	Units
<b>OFF</b>						
Zero Gate Voltage Collector Current	I <sub>CEs</sub>	V <sub>CE</sub> = 600V, V <sub>GE</sub> = 0V	--	--	1	mA
Gate-Emitter Leakage Current	I <sub>GES</sub>	V <sub>CE</sub> = 0V, V <sub>GE</sub> = 20V	--	--	±250	nA
<b>ON</b>						
Gate-Emitter Threshold Voltage	V <sub>GE(TH)</sub>	V <sub>GE</sub> = V <sub>CE</sub> , I <sub>C</sub> = 60mA	4.5	6.0	7.5	V
Collector-Emitter Saturation Voltage	V <sub>CE(SAT)</sub>	V <sub>CE</sub> = 15V, I <sub>C</sub> = 60A, T <sub>J</sub> = 25 °C	--	1.8	2.3	V
		V <sub>CE</sub> = 15V, I <sub>C</sub> = 60A, T <sub>J</sub> = 125 °C	--	2.3	--	V
<b>DYNAMIC</b>						
Input Capacitance	C <sub>IES</sub>	V <sub>CE</sub> = 30V, V <sub>GE</sub> = 0V, f = 1 MHz	--	3300	--	pF
Output Capacitance	C <sub>OES</sub>		--	170	--	pF
Reverse Transfer Capacitance	C <sub>RES</sub>		--	110	--	pF
<b>SWITCHING</b>						
Turn-On Delay Time	t <sub>d(on)</sub>	V <sub>CC</sub> = 400V, I <sub>C</sub> =60A R <sub>G</sub> = 10Ω, V <sub>GE</sub> = 15V Inductive Load, T <sub>J</sub> =25 °C	--	45	--	ns
Rise Time	t <sub>r</sub>		--	125	--	ns
Turn-Off Delay Time	t <sub>d(off)</sub>		--	150	--	ns
Fall Time	t <sub>f</sub>		--	80	120	ns
Turn-On Switching Energy Loss	E <sub>ON</sub>		--	0.3	--	mJ
Turn-Off Switching Energy Loss	E <sub>OFF</sub>		--	1.05	--	mJ
Turn-On Delay Time	t <sub>d(on)</sub>	V <sub>CC</sub> = 400V, I <sub>C</sub> =60A R <sub>G</sub> = 10Ω, V <sub>GE</sub> = 15V Inductive Load, T <sub>J</sub> =125 °C	--	45	--	ns
Rise Time	t <sub>r</sub>		--	135	--	ns
Turn-Off Delay Time	t <sub>d(off)</sub>		--	160	--	ns
Fall Time	t <sub>f</sub>		--	90	--	ns
Turn-On Switching Energy Loss	E <sub>ON</sub>		--	0.32	--	mJ
Turn-Off Switching Energy Loss	E <sub>OFF</sub>		--	1.3	--	mJ
Total Gate Charge	Q <sub>g</sub>	V <sub>CC</sub> = 400V, I <sub>C</sub> =60A V <sub>GE</sub> = 15V	--	150	--	nC
Gate-Emitter Charge	Q <sub>ge</sub>		--	22	--	nC
Gate-Collector Charge	Q <sub>gc</sub>		--	78	--	nC
Short Circuit Withstanding Time	t <sub>sc</sub>	V <sub>CC</sub> = 400V, V <sub>GE</sub> = 15V T <sub>J</sub> =125 °C	10	--	--	μs

### SiC Diode Rating and Characteristics (T<sub>j</sub>=25°C unless otherwise specified)

Parameters	Symbol	Conditions	Min	Typ	Max	Units
Maximum peak repetitive reverse voltage	V <sub>RRM</sub>		600	--	--	V
Maximum Reverse Leakage Current	I <sub>RM</sub>	V <sub>R</sub> = 600V, T <sub>j</sub> = 25 °C	--	3.9	300	μA
		V <sub>R</sub> = 600V, T <sub>j</sub> = 150 °C	--	1455	--	μA
Diode Forward Voltage	V <sub>F</sub>	I <sub>F</sub> = 30A, T <sub>j</sub> = 25 °C	--	1.5	1.7	V
		I <sub>F</sub> = 30A, T <sub>j</sub> = 150 °C	--	2.2	--	V
Total Capacitive Charge	Q <sub>C</sub>	V <sub>R</sub> =600 V, I <sub>F</sub> <I <sub>F,max</sub>	--	75	--	nC
Switching Time	t <sub>C</sub>	dI <sub>F</sub> /dt = 200 A/μs, T <sub>j</sub> = 175 °C	--	--	10	ns
Total Capacitance	C	V <sub>R</sub> = 1V, f = 1 MHz	--	1461	--	pF
		V <sub>R</sub> = 300V, f = 1 MHz	--	129	--	pF
		V <sub>R</sub> = 600V, f = 1 MHz	--	123	--	pF

### Thermal and Package Characteristics (T<sub>j</sub>=25°C unless otherwise specified)

Parameters	Symbol	Conditions	Min	Typ	Max	Units
Junction to Case Thermal Resistance	R <sub>THJC</sub>	IGBT chip	--	--	0.36	°C /W
		SiC SBD chip	--	--	1.54	°C /W
Mounting Torque	M <sub>d</sub>				1.5	N-m
Terminal Connection Torque	M <sub>dt</sub>		1.3	--	1.5	N-m
Package Weight	W <sub>t</sub>			32		g
Isolation Voltage	V <sub>ISOL</sub>	I <sub>ISOL</sub> < 1mA, 50/60Hz, t=1 min	2500	V		

**IGBT Characteristics**

Fig. 1 Output characteristics

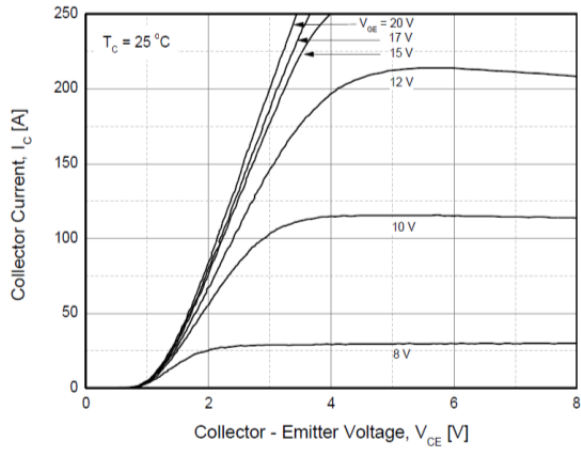


Fig. 2 Saturation voltage characteristics

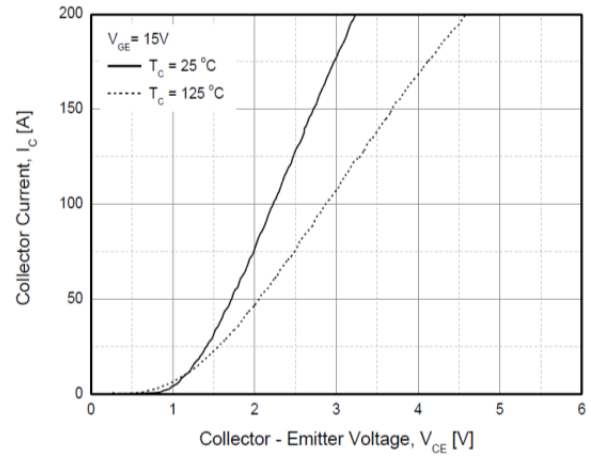


Fig. 3 Saturation voltage vs. collector current

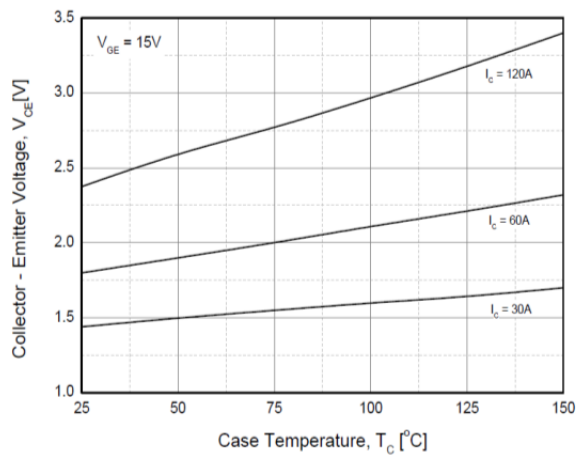


Fig. 4 Saturation voltage vs. gate bias

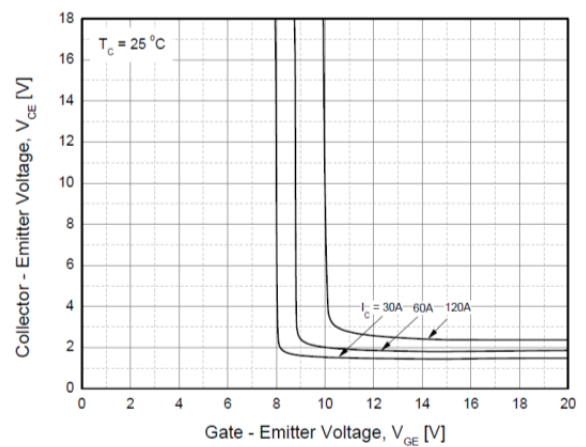


Fig. 5 Saturation voltage vs. gate bias

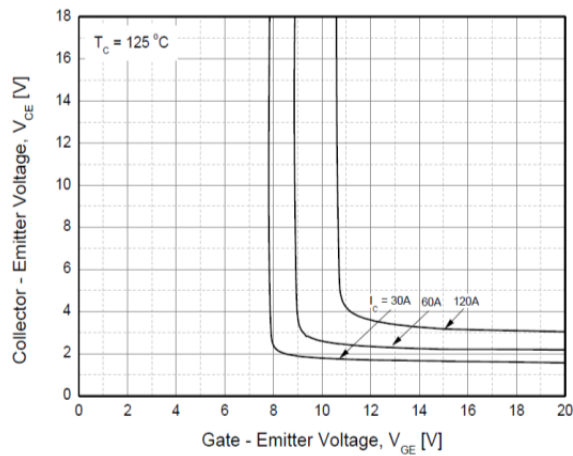


Fig. 6 Capacitance characteristics

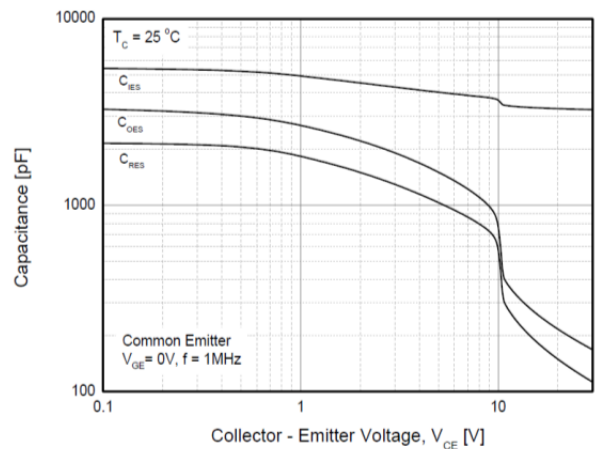


Fig. 7 Turn-on time vs. gate resistance

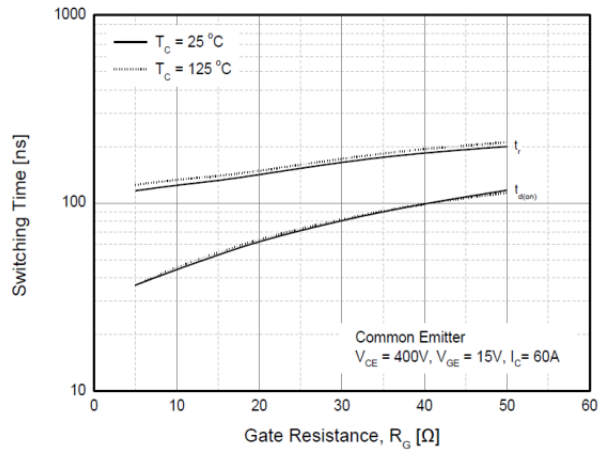


Fig. 8 Turn-off time vs. gate resistance

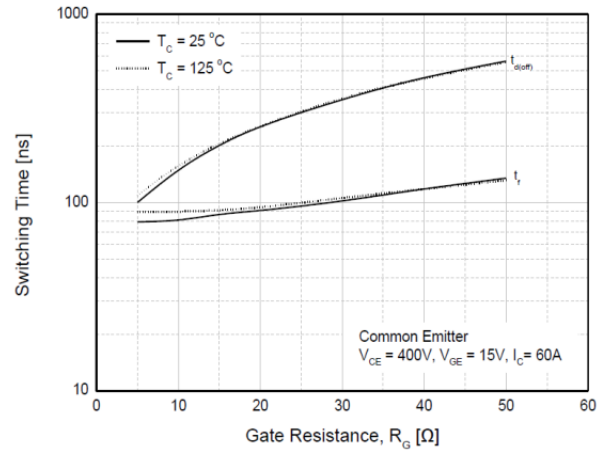


Fig. 9 Switching loss vs. gate resistance

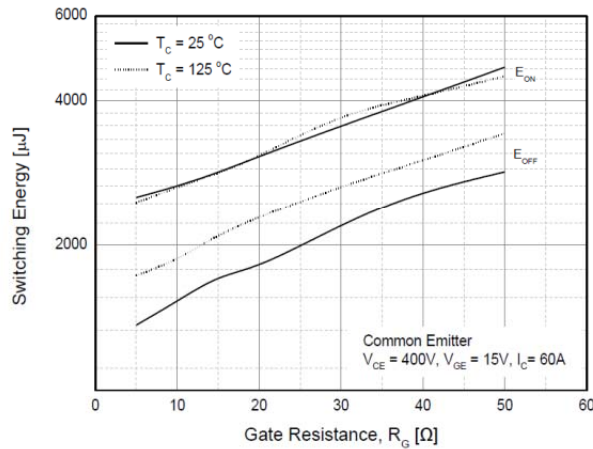


Fig. 10 Turn-on time vs. collector current

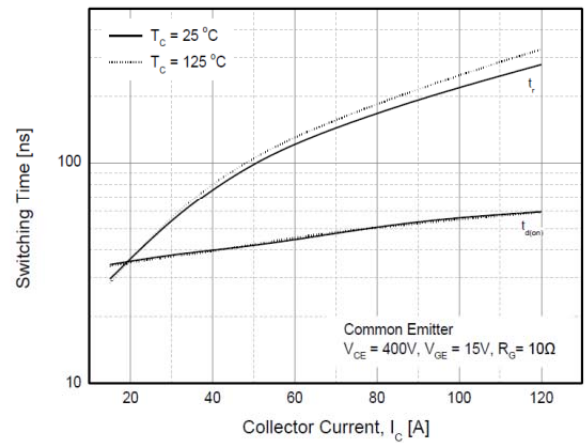


Fig. 11 Turn-off time vs. collector current

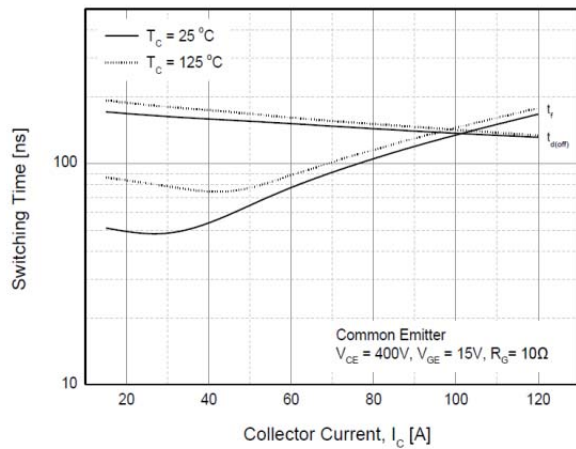


Fig. 12 Switching loss vs. collector current

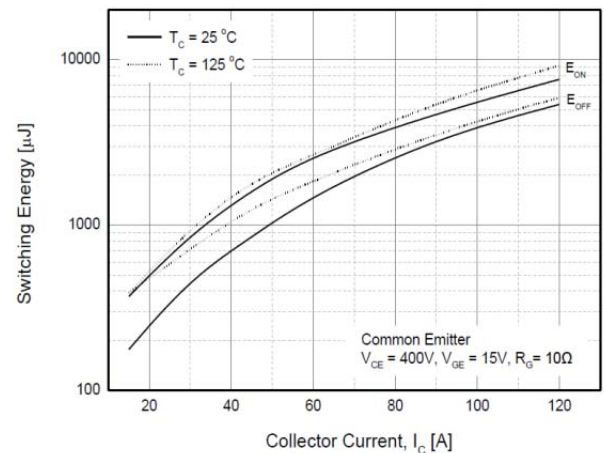


Fig. 13 Gate charge characteristics

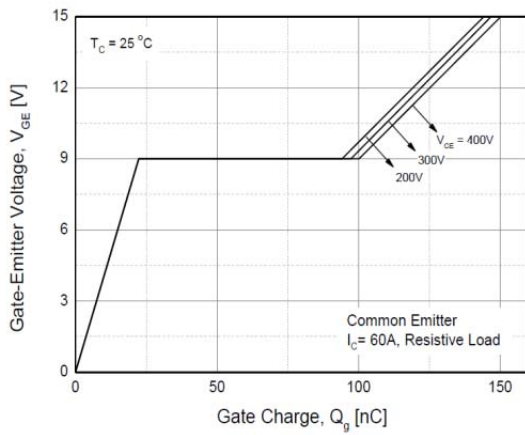


Fig. 14 SOA

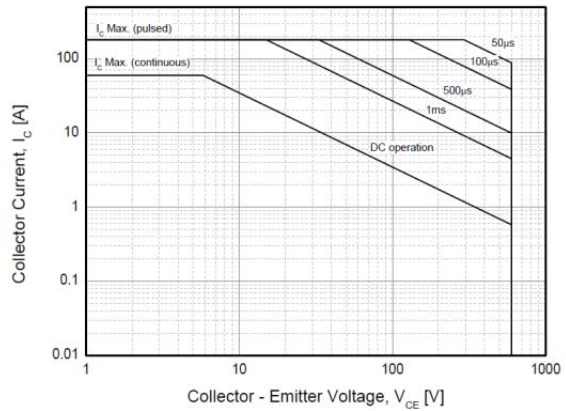


Fig. 15 RBSOA

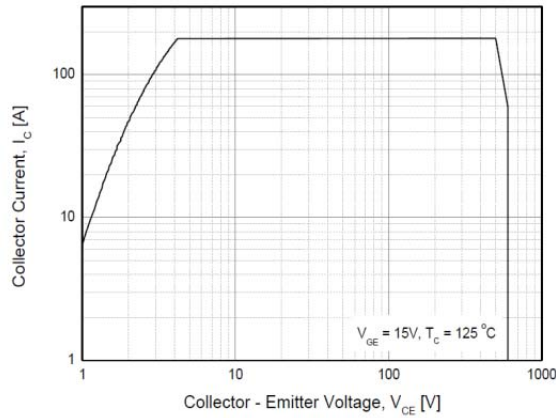
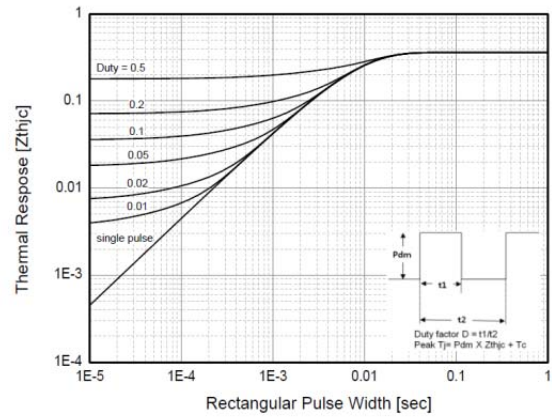
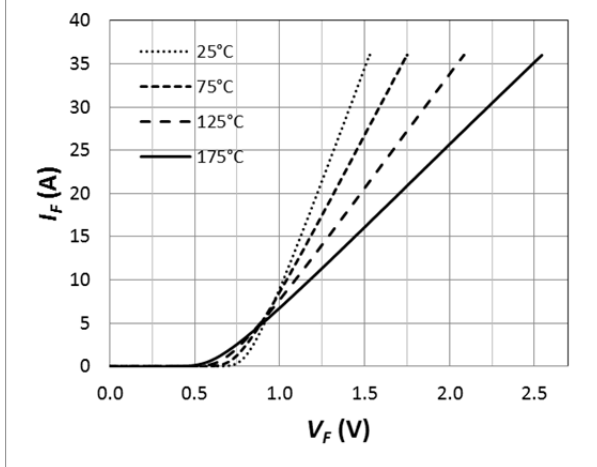


Fig. 16 Transient thermal impedance of IGBT

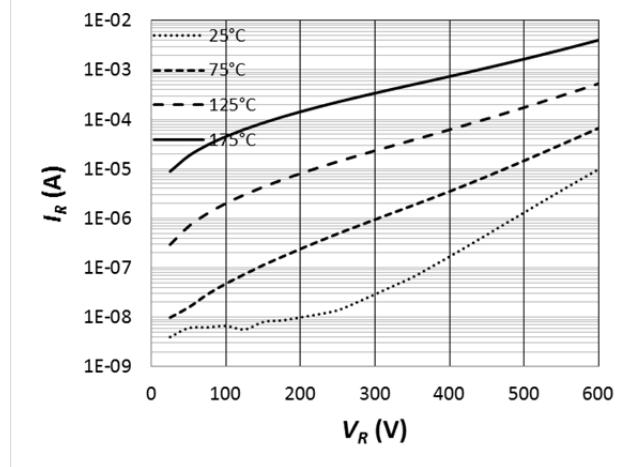


**Boost SiC Diode Characteristics**

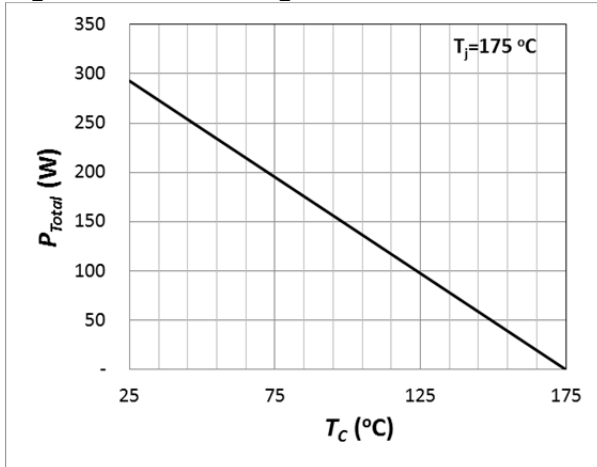
**Fig. 17 Forward Characteristics**



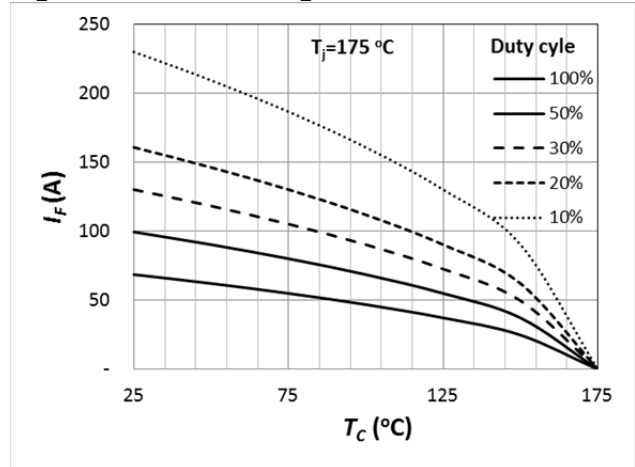
**Fig. 18 Reverse Characteristics**



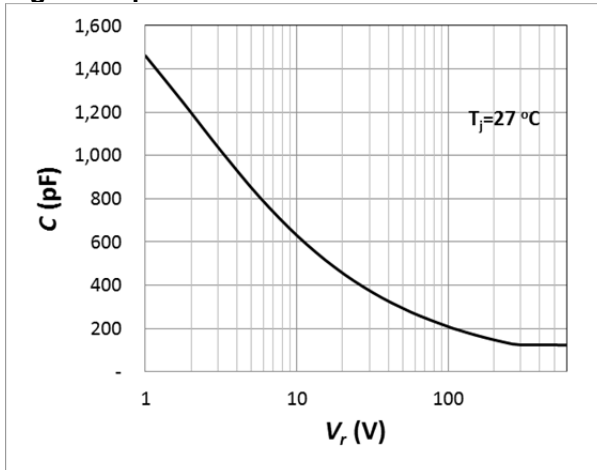
**Fig. 19 Power Derating**



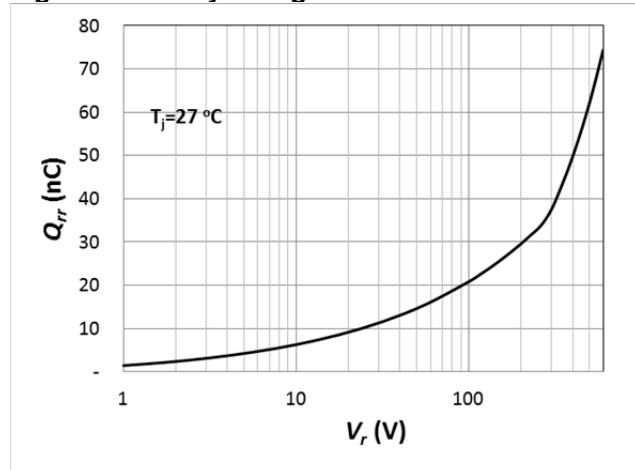
**Fig. 20 Current Derating**



**Fig. 21 Capacitance Curve**

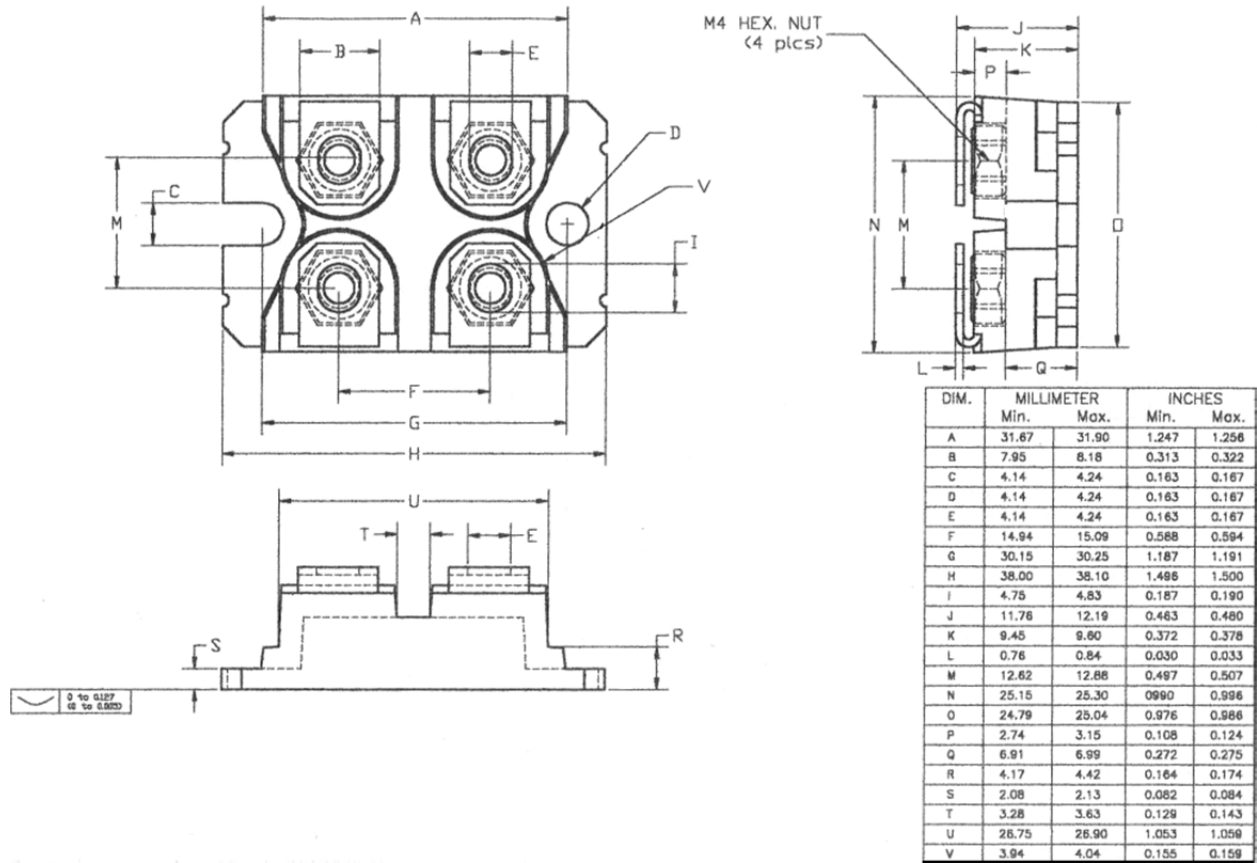


**Fig. 22 Recovery Charge**





### SOT-227 Package Outline



### Revision History

Date	Revision	Notes
6/3/2014	1.0	Initial release

### Global Power Technologies Group

20692 Prism Place  
 Lake Forest, CA 92630  
 TEL (949) 207-7500  
 FAX (949) 613-7600  
 E-mail: [info@gptechnology.com](mailto:info@gptechnology.com)  
 Web site: [www.gptechnology.com](http://www.gptechnology.com)





**Notes**

- **RoHS Compliance**

The levels of RoHS restricted materials in this product are below the maximum concentration values (also referred to as the threshold limits) permitted for such substances, or are used in an exempted application, in accordance with EU Directive 2011/65/EC (RoHS2), as implemented March, 2013. RoHS Declarations for this product can be obtained from the Product Documentation sections of [www.gptechgroup.com](http://www.gptechgroup.com).

- **REACH Compliance**

REACH substances of high concern (SVHCs) information is available for this product. Since the European Chemical Agency (ECHA) has published notice of their intent to frequently revise the SVHC listing for the foreseeable future, please contact our office at GPTG Headquarters in Lake Forest, California to insure you get the most up-to-date REACH SVHC Declaration.

REACH banned substance information (REACH Article 67) is also available upon request.

- This product has not been designed or tested for use in, and is not intended for use in, applications implanted into the human body nor in applications in which failure of the product could lead to death, personal injury or property damage, including but not limited to equipment used in the operation of nuclear facilities, life-support machines, cardiac defibrillators or similar emergency medical equipment, aircraft navigation or communication or control systems, or air traffic control.

- To obtain additional technical information or to place an order for this product, please contact us. The information in this datasheet is provided by Global Power Technologies Group. GPTG reserves the right to make changes, corrections, modifications, and improvements of datasheet without notice.