

THIS DOCUMENT IS THE PROPERTY OF  
KEYSTONE ELECTRONICS CORP. AND  
SHALL NOT BE REPRODUCED, DISTRIBUTED  
OR USED AS A BASIS FOR MANUFACTURE  
WITHOUT PRIOR WRITTEN PERMISSION  
FROM KEYSTONE ELECTRONICS CORP.

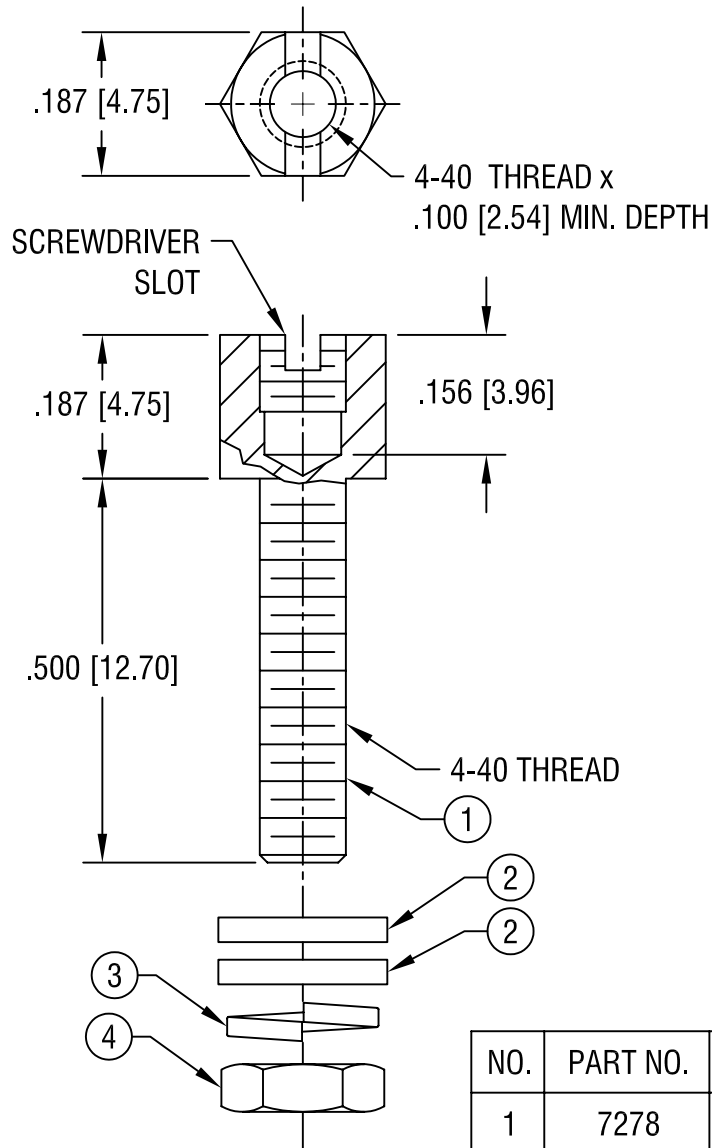

NO.	PART NO.	DESCRIPTION	QTY
1	7278	JACK SCREW	1
2	7235-1	FLAT WASHER	2
3	7235-2	LOCKWASHER	1
4	7235-3	NUT	1

### KEYSTONE ELECTRONICS CORP.

ASTORIA, N.Y. 11105-2017

PART NAME

JACK SCREW W/ SLOT & HARDWARE

MATERIAL

STEEL

FINISH

ZINC PLATE  
CLEAR CHROMATE

DRN BY

BOONE

DATE

3.10.06

APP'D

LN

SCALE

4X

TOLERANCES

INCH [MM]

DECIMAL  $\pm .005$  [ $\pm 0.15$ ]

ANGULAR  $\pm 1^\circ$   
UNLESS OTHERWISE SPECIFIED

CODE

C/M

DWG NO.

7298

DATE

DESCRIPTION

REV.