

XStream™ OEM RF Module



Product Manual v5.x00

For XStream OEM RF Module Part Numbers:

X09-001...	X24-009...	XH9-001...
X09-009...	X24-019...	XH9-009...
X09-019...		XH9-019...

Reliable 900 MHz and 2.4 GHz OEM RF Modules by Digi International Inc.



XStream OEM RF Module – Product Manual v5.x00

(Part number 90002209 B)

Revision	Date	Description
B	10/15/14	Minor changes and new part number

© 2014 Digi International Inc. All rights reserved

Digi, Digi International, the Digi logo, and XStream® are trademarks or registered trademarks of Digi International Inc. in the United States and other countries worldwide. All other trademarks mentioned in this document are the property of their respective owners.

Information in this document is subject to change without notice and does not represent a commitment on the part of Digi International. Digi provides this document “as is,” without warranty of any kind, expressed or implied, including, but not limited to, the implied warranties of fitness or merchantability for a particular purpose. Digi may make improvements and/or changes in this manual or in the product(s) and/or the program(s) described in this manual at any time.

Contents

1. XStream OEM RF Module	4	IC (Industry Canada) Certification	53
1.1. Features	4	Appendix B: Development Guide	54
1.1.1. Worldwide Acceptance	5	XStream OEM Development Kit Contents	54
1.2. Specifications	5	Interfacing Hardware	54
1.3. Mechanical Drawings	6	Adapters	58
1.4. Pin Signals	6	Antennas	59
1.5. Electrical Characteristics	8	Interfacing Protocols	60
1.5.1. Timing Specifications	8	RS-232 Operation	60
2. RF Module Operation	10	RS-485 (2-wire) Operation	62
2.1. Serial Communications	10	RS-485 (4-wire) and RS-422 Operation	63
2.1.1. UART-Interfaced Data Flow	10	XCTU Software	65
2.1.2. Flow Control	11	Using the XCTU Software	65
2.2. Modes of Operation	12	Appendix C: Additional Information	66
2.2.1. Idle Mode	12	1-Year Warranty	66
2.2.2. Transmit Mode	12	Ordering Information	66
2.2.3. Receive Mode	14	Contact Digi	67
2.2.4. Sleep Mode	14		
2.2.5. Command Mode	17		
3. RF Module Configuration	19		
3.1. Hands-on Programming Examples	19		
3.1.1. AT Command Example	19		
3.1.3. Binary Command Example	20		
3.2. Command Reference Table	21		
3.3. XStream Command Descriptions	22		
4. RF Communication Modes	37		
4.1. Addressing	38		
4.1.1. Address Recognition	38		
4.2. Basic Communications	39		
4.2.1. Streaming Mode (Default)	39		
4.2.2. Repeater Mode	40		
4.3. Acknowledged Communications	44		
4.3.1. Acknowledged Mode	44		
4.3.2. Multi-Streaming Mode	46		
Appendix A: Agency Certifications	50		
FCC Certification	50		
OEM Labeling Requirements	51		
Antenna Usage	51		
FCC-Approved Antennas	52		

1. XStream OEM RF Module

The XStream OEM RF Module is a drop-in wireless data solution that transfers a standard asynchronous serial data stream over-the-air between devices. The module was engineered to provide OEMs and integrators with an easy-to-use wireless solution that yields reliable, long range and low cost wireless links.



1.1. Features

Long Range

9XStream (900 MHz) Range:

- Indoor/Urban: up to 1500' (450 m)
- Outdoor line-of-sight: up to 7 miles (11 km) w/ 2.1 dBm dipole antenna
- Outdoor line-of-sight: up to 20 miles (32 km) w/ high gain antenna

24XStream (2.4 GHz) Range:

- Indoor/Urban: up to 600' (180 m)
- Outdoor line-of-sight: up to 3 miles (5 km) w/ 2.1 dBm dipole antenna
- Outdoor line-of-sight: up to 10 miles (16 km) w/ high gain antenna

Receiver Sensitivity: -110 dBm (900 MHz),
-105 dBm (2.4 GHz)

Advanced Networking and Security

True peer-to-peer (no "master" required), point-to-point, point-to-multipoint, multidrop

Retries and Acknowledgements

7 hopping channels, each with over 65,000 available network addresses

FHSS (Frequency Hopping Spread Spectrum)

Fast network synchronization (~ 35 ms)

Streaming, Repeater, Multi-Streaming and Acknowledged Modes supported

Easy-to-Use

No configuration required

Advanced configurations supported through standard AT and binary Commands

5 VDC (± 0.25 V) power supply

Continuous RF data stream up to 19.2 kbps

Portable (small form factor easily designed into a wide range of data radio systems)

Software-selectable serial interfacing rates

MODBUS, CTS, RTS, DTR, DCD (and more) I/O Support

Support for multiple data formats (parity, start and stop bits, etc.)

XII™ Interference Immunity

Power-saving Sleep Modes

1.1.1. Worldwide Acceptance

FCC Certified (USA) – Refer to Appendix A for FCC Requirements.

Systems that include XStream Modules automatically inherit Digi Certifications



ISM (Industrial, Scientific and Medical) frequency band

Manufactured under **ISO 9001:2000 registered standards**

9XStream (900 MHz) OEM RF Modules are approved for use in **US, Canada, Australia, Israel.**

1.2. Specifications

Table 1-01. XStream OEM RF Module Specifications

Specification	9XStream (900 MHz) OEM RF Module		24XStream (2.4 GHz) OEM RF Module	
Performance				
Indoor/Urban Range	up to 1500' (450 m)		up to 600' (180 m)	
Outdoor line-of-sight Range	Up to 7 miles (11 km) w/ dipole antenna Up to 20 miles (32 km) w/ high-gain antenna		Up to 3 miles (5 km) w/ dipole antenna Up to 10 miles (16 km) w/ high-gain antenna	
Interface Data Rate	1200 – 57,600 bps (non-standard baud rates also supported)		1200 – 57,600 bps (non-standard baud rates also supported)	
Throughput Data Rate	9,600 bps	19,200 bps	9,600 bps	19,200 bps
RF Data Rate	10,000 bps	20,000 bps	10,000 bps	20,000 bps
Transmit Power Output	100 mW (20 dBm)	100 mW (20 dBm)	50 mW (17 dBm)	50 mW (17 dBm)
Receiver Sensitivity	-110 dBm	-107 dBm	-105 dBm	-102 dBm
Power Requirements				
Supply Voltage	5 VDC (± 0.25 V) regulated		5 VDC (± 0.25 V) regulated	
Receive Current	50 mA		80 mA	
Transmit Current	140 mA		150 mA	
Power Down Current	< 26 µA		< 26 µA	
General				
Frequency Range	902-928 MHz		2.4000-2.4835 GHz	
Spread Spectrum	Frequency Hopping, Wide band FM modulator			
Network Topology	Peer-to-Peer, Point-to-Multipoint, Point-to-Point, Multidrop			
Channel Capacity	7 hop sequences share 25 frequencies			
Serial Data Interface	CMOS UART			
Physical Properties				
Module Board Size	1.600" x 2.825" x 0.350" (4.06 cm x 7.18 cm x 0.89 cm)			
Weight	0.8 oz (24 g)			
Connector	11-pin and 4-pin, 0.1" spaced male Berg-type headers			
Operating Temperature	0 to 70° C (commercial), -40 to 85° C (industrial)			
Antenna				
Integrated Wire (optional)	¼ wave monopole, 3" (7.62 cm) length, 1.9 dBi Gain			
Connector (optional)	Reverse-polarity SMA or MMCX			
Impedance	50 ohms unbalanced			
Certifications (visit www.digi.com for complete list)				
FCC Part 15.247	OUR9XSTREAM		OUR-24XSTREAM	
Industry Canada (IC)	4214A-9XSTREAM		4214A 12008	

1.3. Mechanical Drawings

Figure 1-01. XStream Module Mechanical Drawings (shown with RPSMA antenna connector option)

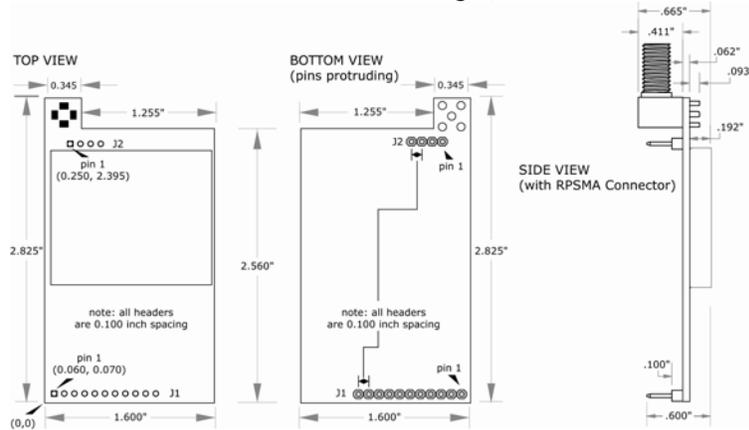

1.4. Pin Signals

Figure 1-02. XStream OEM RF Module Pin Numbers (bottom view, pins protruding)



Table 1-02. J1 Pin Signal Descriptions
(Low-asserted signals distinguished with a horizontal line over signal name.)

Module Pin	Signal Name	I/O	When Active	Function
1	DO2 / $\overline{\text{CTS}}$ RS-485 Enable	O*	low	$\overline{\text{CTS}}$ (clear-to-send) flow control – When pin is driven low, UART host is permitted to send serial data to the module. Refer to the Serial Communications (p9) and CS Command (p23) sections for more information. RS-485 Enable – To configure this pin to enable RS-485 (2-wire or 4-wire) communications, refer to the Serial Communications (p9) and CS Command (p23) sections.
2	DI3 / SLEEP	I*	high	By default, DI3 pin is not used. To configure this pin to support Sleep Modes, refer to the Sleep Mode (p13), SM Command (p32) and PW Command (p29) sections.
3	DO (data out)	O*	n/a	Serial data exiting the module (to the UART host). Refer to the Serial Communications (p9) section for more information.
4	DI (data in)	I	n/a	Serial data entering the module (from UART host). Refer to the Serial Communications (p9) section for more information.
5	DI2 / $\overline{\text{RTS}}$ CMD	I**	low	$\overline{\text{RTS}}$ (request-to-send) flow control – By default, this pin is not used. To configure this pin to regulate the flow of serial data exiting the module, refer to the Serial Communications (p9) and RT Command (p31) sections. CMD –Refer to Binary Commands (p17) and RT Command (p31) sections to enable binary command programming.
6	$\overline{\text{RESET}}$	I*	low	Re-boot module.
7	DO3 / RX LED	O	high	Pin is driven high during RF data reception; otherwise, the pin is driven low. Refer to the CD Command (p22) to enable.
8	$\overline{\text{TX}}$ / PWR	O	low	$\overline{\text{TX}}$ - Pin pulses low during RF transmission.
			high	PWR – Indicates power is on and module is not in Sleep Mode.
9	$\overline{\text{CONFIG}}$	I***	low	Pin can be used as a backup method for entering Command Mode during power-up. Primary method is with “+++”. Refer to the Command Mode (p16) section for more information.
10	VCC	I	-	5 VDC regulated (± 0.25)
11	GND	-	-	Ground

- * Module has 10K Ω internal pull-up resistor
- ** Module has 10K Ω internal pull-down resistor
- *** Module has 100K Ω internal pull-up resistor

Note: When integrating the XStream Module with a Host PC Board, all lines that are not used should be left disconnected (floating).

Table 1-03. J2 Pin Signal Descriptions

Module Pin	Signal Name
1	reserved
2	GND
3	GND
4	GND

J2 Pins are used primarily for mechanical stability and may be left disconnected.

1.5. Electrical Characteristics

Figure 1-03. System Block Diagram

Basic wireless link between hosts

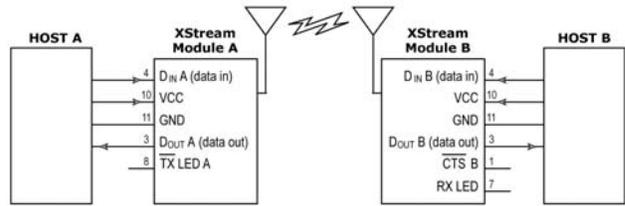

The data flow sequence is initiated when the first byte of data is received in the DI Buffer of the transmitting module (XStream Module A). As long as XStream Module A is not already receiving RF data, data in the DI Buffer is packetized, then transmitted over-the-air to XStream Module B. Once received, the data is shifted out serial port to Host B.

1.5.1. Timing Specifications

Figure 1-04. Timing Specifications (“A” and “B” refer to Figure 1-03.)

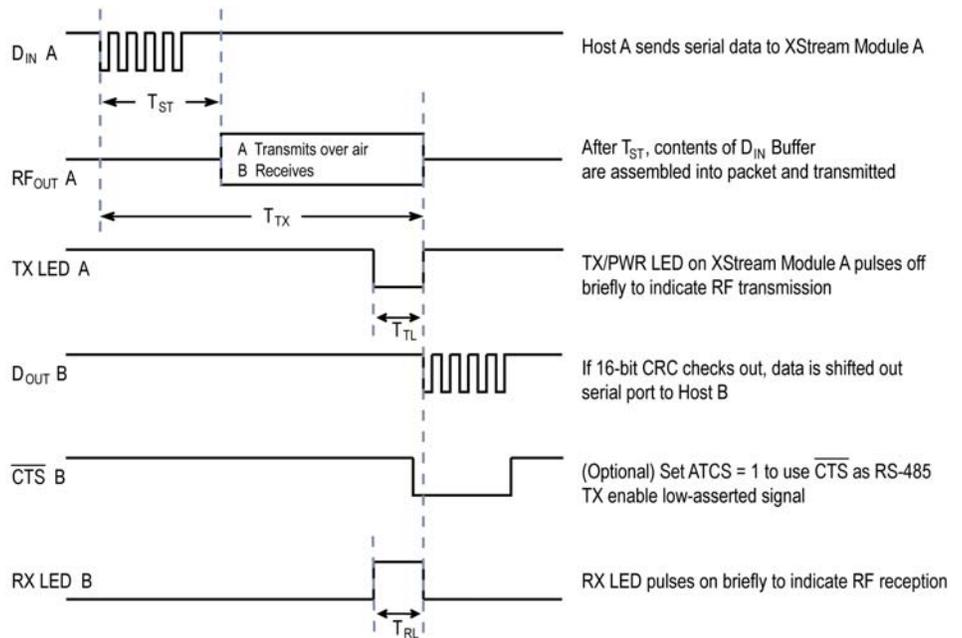

Table 1-04. AC Characteristics (SY parameter = 0, symbols correspond to Figure 1-03 and Figure 1-04.)

Symbol	Description	19200 baud rate (32 byte packet)	19200 timing (B=number of bytes)	9600 baud rate (32 byte packet)	9600 timing (B=number of bytes)
T _{TX}	Latency from the time data is transmitted until received	54.0 ms	For 0 < B < 64, T = 41.6 + (0.4 * B) ms For B > 63, T = 66.8 ms	72.0 ms	For 0 < B < 40, T = 46.27 + (0.73 * B) ms For B >= 39 bytes, T = 74.80 ms
T _{TL}	Time that TX/PWR pin is driven low	8.4 ms	For 0 < B < 14, T = 3.24 + (0.4 * B) ms For B > 13, T = 8.48 ms	16.8 ms	For 0 < B < 14, T = 6.50 + (0.8 * B) ms For B > 13, T = 16.80 ms
T _{RL}	Time that RX LED pin is driven high	13.6 ms	For 0 < B < 65, T = 0.79 + (0.408 * B) For B > 64, T = 26.9 ms	25.6 ms	For 0 < B < 37, T = 1.63 + (0.794 * B) For B > 36, T = 30.2 ms
T _{ST}	Channel Initialization Time	35.0 ms	35.0 ms	35.0 ms	35.0 ms

Table 1-05. DC Characteristics (Vcc = 4.75 – 5.25 VDC)

Symbol	Parameter	Condition	Min	Typical	Max	Units
VIL	Input Low Voltage	All input signals	-0.5		0.3 * Vcc	V
VIH	Input High Voltage	All except RESETpin	0.6 * Vcc		Vcc + 0.5	V
VIH2	Input High Voltage	pin *	0.9 * Vcc		Vcc + 0.5	V
VOL	Output Low Voltage	IOL = 20 mA, Vcc = 5V			0.7 0.5	V
VOH	Output High Voltage	IOH = -20 mA, Vcc = 5V	4.0 2.0			V
IIL	Input Leakage Current I/O Pin	Vcc = 5.5V, pin low (absolute value)			3	μA
IIH	Input Leakage Current I/O Pin	Vcc = 5.5V, pin high (absolute value)			3	μA
IIL2		$\overline{\text{CTS}}$ $\overline{\text{RESET}}$ DO		(Vcc - VI) / 10 **		mA
IIL3		CONFIG		(Vcc - VI) / 47 **		mA
IIH2		$\overline{\text{RTS}}$		(Vcc - VI) / 10 **		mA

* Reset pulse must last at least 250 nanoseconds

** VI = the input voltage on the pin

2. RF Module Operation

2.1. Serial Communications

The XStream OEM RF Module interfaces to a host device through a CMOS-level asynchronous serial port. Through its serial port, the module can communicate with any UART voltage compatible device or through a level translator to any RS-232/485/422 device.

2.1.1. UART-Interfaced Data Flow

Devices that have a UART interface can connect directly through the pins of the XStream Module as is shown in the figure below.

Figure 2-01. System Data Flow Diagram in a UART-interfaced environment
(Low-asserted signals distinguished with horizontal line over signal name.)

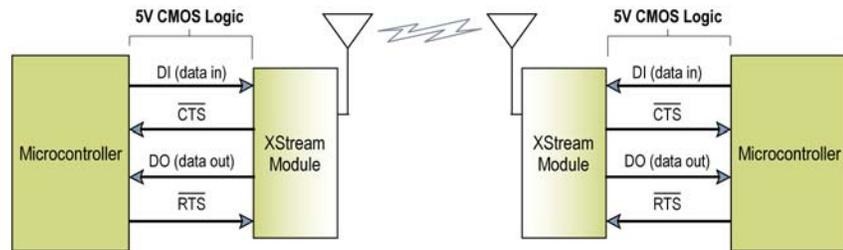

Serial Data

Data enters the XStream Module through the DI pin (pin 4) as an asynchronous serial signal. The signal should idle high when no data is being transmitted.

The UART performs tasks, such as timing and parity checking, that are needed for data communications. Serial communication consists of two UARTs configured with compatible parameters (baud rate, parity, start bits, stop bits, data bits) to have successful communication. Each data packet consists of a start bit (low), 8 data bits (least significant bit first) and a stop bit (high). The following figure illustrates the serial bit pattern of data passing through the module.

Figure 2-02. UART data packet 0x1F (decimal number "31") as transmitted through the XStream Module

Example Data Format is 8-N-1 (bits – parity - # of stop bits)

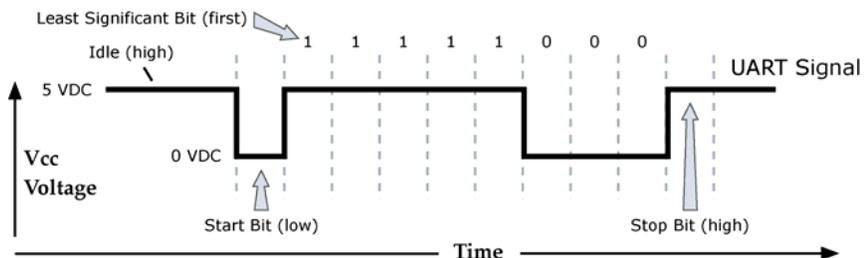

2.1.2. Flow Control

Figure 2-03. Internal Data Flow Diagram (The five most commonly-used pin signals shown.)

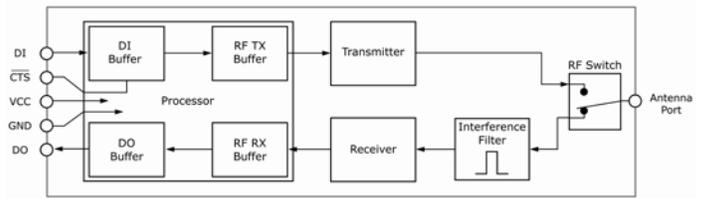

DI (Data In) Buffer and Flow Control

When serial data enters the XStream Module through the DI Pin (pin 4), then the data is stored in the DI Buffer until it can be transmitted.

When the RB and RO parameter thresholds are satisfied (refer to Transmit Mode section (p11) and command descriptions for more information), the module attempts to initialize an RF connection. If the module is already receiving RF data, the serial data is stored in the DI Buffer. The size of the DI Buffer can be determined by issuing the RZ (DI Buffer Size) Command. If the DI buffer becomes full, hardware or software flow control must be implemented in order to prevent overflow (loss of data between the host and XStream Module).

How to eliminate the need for flow control:

1. Send messages that are smaller than the DI buffer size. The size of the DI buffer varies according to the packet size (PK parameter) and the parity setting (NB parameter) used.
2. Interface at a lower baud rate (BD parameter) than the fixed RF data rate.

Two cases in which the DI Buffer may become full and possibly overflow:

1. If the serial interface data rate is set higher than the RF data rate of the module, the module will receive data from the host faster than it can transmit the data over-the-air.
2. If the module is receiving a continuous stream of RF data or monitoring data on a network, any serial data that arrives on the DI pin is placed in the DI Buffer. The data in the DI buffer will be transmitted over-the-air when the module no longer detects RF data in the network.

Hardware Flow Control ($\overline{\text{CTS}}$). When the DI buffer is 17 bytes away from being full; by default, the module de-asserts (high) $\overline{\text{CTS}}$ to signal to the host device to stop sending data (refer to FT (Flow Control Threshold) and CS (DO2 Configuration) Commands). $\overline{\text{CTS}}$ is re-asserted after the DI Buffer has 34 bytes of memory available.

Software Flow Control (XON). XON/XOFF software flow control can be enabled using the FL (Software Flow Control) Command. This option only works with ASCII data.

DO (Data Out) Buffer and Flow Control

When RF data is received, the data enters the DO buffer and is then sent out the serial port to a host device. Once the DO Buffer reaches capacity, any additional incoming RF data is lost. The size of the DO Buffer can be determined by issuing the RZ (DI Buffer Size) Command, then multiplying the result by 1.5.

Two cases in which the DO Buffer may become full and possibly overflow:

1. If the RF data rate is set higher than the interface data rate of the module, the module will receive data from the transmitting module faster than it can send the data to the host.
2. If the host does not allow the module to transmit data out from the DO buffer because of being held off by hardware or software flow control.

Hardware Flow Control ($\overline{\text{RTS}}$). If $\overline{\text{RTS}}$ is enabled for flow control (RT Parameter = 2), data will not be sent out the DO Buffer as long as $\overline{\text{RTS}}$ (pin 5) is de-asserted

Software Flow Control (XOFF). XON/XOFF software flow control can be enabled using the FL (Software Flow Control) Command. This option only works with ASCII data.

2.2. Modes of Operation

XStream OEM RF Modules operate in five modes.

Figure 2-04. XStream Modes of Operation

The module can only be in one mode at a time.

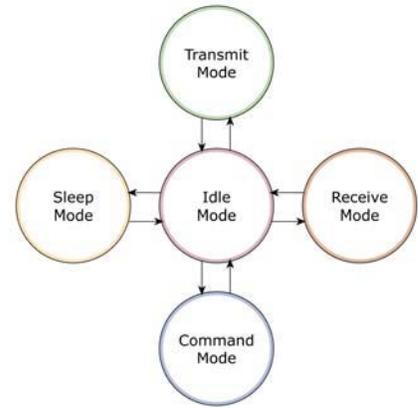

2.2.1. Idle Mode

When not receiving or transmitting data, the module is in Idle Mode. The module uses the same amount of power in Idle Mode as it does in Receive Mode.

The module shifts into the other modes of operation under the following conditions:

- Serial data is received in the DI Buffer (Transmit Mode)
- Valid RF data is received through the antenna (Receive Mode)
- Command Mode Sequence is issued (Command Mode)
- Sleep Mode condition is met (Sleep Mode)

After responding to any of the preceding conditions, the module automatically transitions back into Idle Mode.

2.2.2. Transmit Mode

After the first byte of serial data is received in the DI buffer (from the UART), the module attempts to shift to Transmit Mode and initiate RF connections with other modules. After transmission is complete, the module returns to Idle Mode.

Note: RF reception must complete before the module is able to enter into Transmit Mode.

RF transmission begins after either of the following criteria is met:

1. RB bytes have been received in the DI buffer and are pending for RF transmission (refer to RB (Packetization Threshold) Command, p29).
The RB parameter may be set to any value between 1 and the RF packet size (PK), inclusive. When RB = 0, the packetization threshold is ignored.
2. At least one character has been received in the DI buffer (pending for RF transmission) and RO time has been observed on the UART (refer to RO (Packetization Timeout) Command).
The timeout can be disabled by setting RO to zero. In this case, transmission will begin after RB bytes have been received in the DI buffer.

After either RB or RO conditions are met, the module then initializes a communications channel. (Channel Initialization is the process of sending an RF initializer that synchronizes receiving modules with the transmitting module. During channel initialization, incoming serial data accumulates in the DI buffer.)

Serial data in the DI buffer is grouped into RF packets (refer to PK (RF Packet Size)); converted to RF data; then transmitted over-the-air until the DI buffer is empty.

RF data, which includes the payload data, follows the RF initializer. The payload includes up to the maximum packet size (PK Command) bytes. As the transmitting module nears the end of the transmission, it inspects the DI buffer to see if more data exists to be transmitted. This could be the case if more than PK bytes were originally pending in the DI buffer or if more bytes arrived from the UART after the transmission began. If more data is pending, the transmitting module assembles a subsequent packet for transmission.

Figure 2-05. Data Transmission Sequence

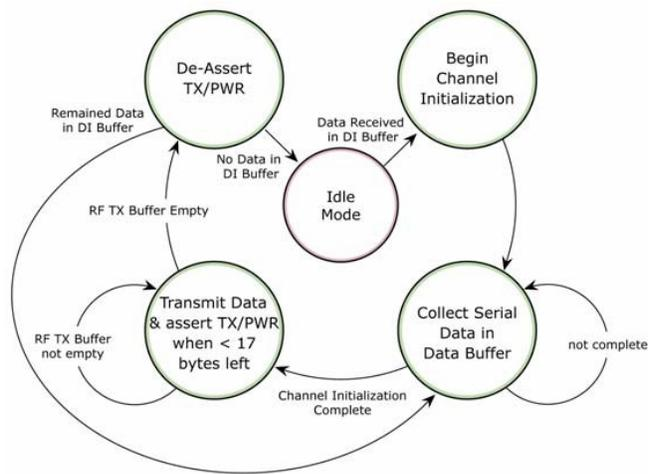

RF Data Packet

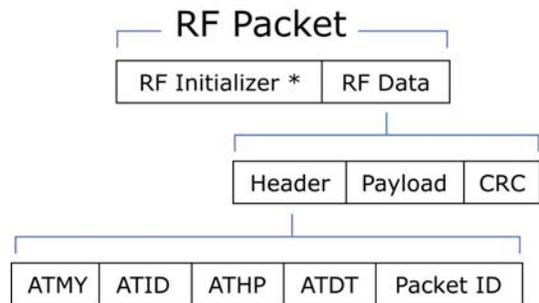

Figure 2-06. RF Data Packet

* When streaming multiple RF packets, the RF Initializer is only sent in front of the first packet.

RF Initializer

An RF initializer is sent each time a new connection sequence begins. The RF initializer contains channel information that notifies receiving modules of information such as the hopping pattern used by the transmitting module. The first transmission always sends an RF initializer.

An RF initializer can be of various lengths depending on the amount of time determined to be required to prepare a receiving module. For example, a wake-up initializer is a type of RF initializer used to wake remote modules from Sleep Mode (Refer to the FH, LH, HT and SM

Commands for more information). The length of the wake-up initializer should be longer than the length of time remote modules are in cyclic sleep.

Header

The header contains network addressing information that filters incoming RF data. The receiving module checks for a matching Hopping Channel (HP parameter), Vendor Identification Number (ID parameter) and Destination Address (DT parameter). Data that does not pass through all three network filter layers is discarded.

CRC (Cyclic Redundancy Check)

To verify data integrity and provide built-in error checking, a 16-bit CRC (Cyclic Redundancy Check) is computed for the transmitted data and attached to the end of each RF packet. On the receiving end, the receiving module computes the CRC on all incoming RF data. Received data that has an invalid CRC is discarded. (See Receive Mode section.)

2.2.3. Receive Mode

If the module detects RF data while in Idle Mode, the module transitions into Receive Mode to receive RF packets. Once a packet is received, the module checks the CRC to ensure that the data was transmitted without error. If the CRC data bits on the incoming packet are invalid, the packet is discarded. If the CRC is valid, the packet proceeds to the DO Buffer.

The module returns to Idle Mode when valid RF data is no longer detected or after an error is detected in the received RF data.

Figure 2-07. Data Reception Sequence ⚠

* Refer to the Addressing section (p36) of the RF Communication Modes chapter for more information regarding address recognition.

Note: If serial data exists in the DI buffer while the module is in Receive Mode, the UART data will be transmitted after the module is finished receiving the RF data and has returned to Idle Mode.

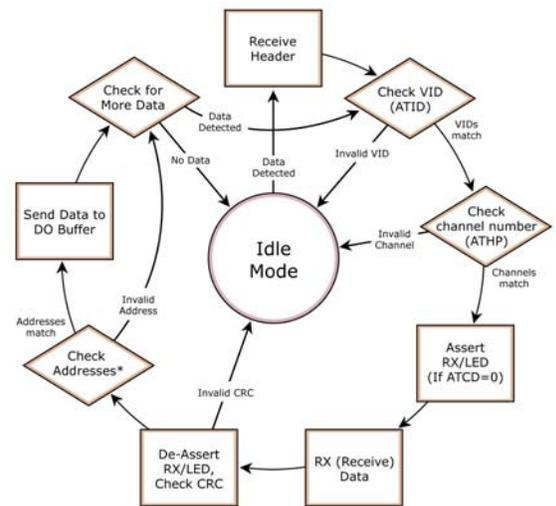

2.2.4. Sleep Mode

Sleep Modes enable the XStream Module to operate at minimal power consumption when not in use. Three Sleep Mode options are available:

- **Pin Sleep** (Host Controlled)
- **Serial Port Sleep** (Wake on Serial Port activity)
- **Cyclic Sleep** (Wake on RF activity)

For the module to transition into Sleep Mode, the module must have a non-zero SM (Sleep Mode) Parameter and one of the following must occur:

1. The module is idle (no data transmission or reception) for a user-defined period of time (See ST (Time before Sleep) Command)
2. DI3 (pin 2) is asserted (only for Pin Sleep option)

In Sleep Mode, the module will not transmit or receive data until the module first transitions to Idle Mode. All Sleep Modes are enabled and disabled using SM Command. Transitions into and out of Sleep Modes are triggered by various mechanisms as shown in the table below.

Table 2-01. Summary of Sleep Mode Configurations

Sleep Mode Setting	Transition into Sleep Mode	Transition out of Sleep Mode	Related Commands	Typical Power Consumption
Pin Sleep (SM = 1)	Microcontroller can shut down and wake modules by asserting (high) SLEEP (pin 2). Note: Module will complete transmission / reception before activating Pin Sleep.	De-assert (low) SLEEP (pin 2).	SM	26 μ A
Serial Port Sleep (SM = 2)	Automatic transition to Sleep Mode occurs after a user-defined period of inactivity (no transmitting or receiving of data). The period of activity is defined using the ST (Time before Sleep) Command.	When serial byte is received on the DI pin (pin 4).	SM, ST	1 mA
Cyclic Sleep (SM = 3-8)	Automatic transition to Sleep Mode occurs in cycles as defined by the SM (Sleep Mode) Command. Note: The cyclic sleep time interval must be shorter than the "Wake-up Initializer Timer" (set by LH Command).	After the cyclic sleep time interval elapses. Note: Module can be forced into Idle Mode if PW (Pin Wake-up) Command is issued.	SM, ST, HT, LH, PW	76 μ A when sleeping

For more information about Sleep Modes, refer to the individual commands listed in "Related Commands" column of the table. The SM command is central to all Sleep Mode configurations.

Pin Sleep (SM = 1)

Pin Sleep requires the least amount of power. In order to achieve this state, SLEEP pin must be asserted (high). The module remains in Pin Sleep until the SLEEP pin is de-asserted.

After enabling Pin Sleep Mode, the SLEEP pin controls whether the module is active or in Sleep Mode. When SLEEP is de-asserted (low), the module is fully operational. When SLEEP is asserted (high), the module transitions to Sleep Mode and remains in its lowest power-consuming state until the SLEEP pin is de-asserted. SLEEP is only active if the module is setup to operate in this mode; otherwise the pin is ignored.

Once in Pin Sleep Mode, \overline{CTS} is de-asserted (high), indicating that data should not be sent to the module. The PWR pin is also de-asserted (low) when the module is in Pin Sleep Mode.

Note: The module will complete a transmission or reception before activating Pin Sleep.

Serial Port Sleep (SM = 2)

Serial Port Sleep is a Sleep Mode in which the XStream Module runs in a low power state until serial data is detected on the DI pin.

When Serial Port Sleep is enabled, the module goes into Sleep Mode after a user-defined period of inactivity (no transmitting or receiving of data). This period of time is determined by ST (Time before Sleep) Command. Once a character is received through the DI pin, the module returns to Idle Mode and is fully operational.

Cyclic Sleep (SM = 3-8)

Cyclic Sleep is the Sleep Mode in which the XStream Module enters into a low-power state and awakens periodically to determine if any transmissions are being sent.

When Cyclic Sleep settings are enabled, the XStream Module goes into Sleep Mode after a user-defined period of inactivity (no transmission or reception on the RF channel). The user-defined period is determined by ST (Time before Sleep) Command.

While the module is in Cyclic Sleep Mode, \overline{CTS} is de-asserted (high) to indicate that data should not be sent to the module during this time. When the module awakens to listen for data, \overline{CTS} is asserted and any data received on the DI Pin is transmitted. The PWR pin is also de-asserted (low) when the module is in Cyclic Sleep Mode.

The module remains in Sleep Mode for a user-defined period of time ranging from 0.5 seconds to 16 seconds (SM Parameters 3 through 8). After this interval of time, the module returns to Idle Mode and listens for a valid data packet for 100 ms. If the module does not detect valid data (on any frequency), the module returns to Sleep Mode. If valid data is detected, the module transitions into Receive Mode and receives incoming RF packets. The module then returns to Sleep Mode after a Period of inactivity that is determined by ST “Time before Sleep” Command.

The module can also be configured to wake from cyclic sleep when SLEEP (pin 2) is de-asserted (low). To configure a module to operate in this manner, PW (Pin Wake-up) Command must be issued. Once SLEEP is de-asserted, the module is forced into Idle Mode and can begin transmitting or receiving data. It remains active until no data is detected for the period of time specified by the ST Command, at which point it resumes its low-power cyclic state.

Note: The cyclic interval time defined by SM (Sleep Mode) Command must be shorter than the interval time defined by LH (Wake-up Initializer Timer).

For example: If SM=4 (Cyclic 1.0 second sleep), the LH Parameter should equal 0x0B (“1.1” seconds). With these parameters set, there is no risk of the receiving module being asleep for the duration of wake-up initializer transmission. “Cyclic Scanning” explains in further detail the relationship between “Cyclic Sleep” and “Wake-up Initializer Timer”

Cyclic Scanning. Each RF transmission consists of an RF Initializer and payload. The wake-up initializer contains initialization information and all receiving modules must wake during the wake-up initializer portion of data transmission in order to be synchronized with the transmitting module and receive the data.

Figure 2-08. Correct Configuration (LH > SM)

Length of the wake-up initializer exceeds the time interval of Cyclic Sleep. The receiver is guaranteed to detect the wake-up initializer and receive the accompanying payload data.

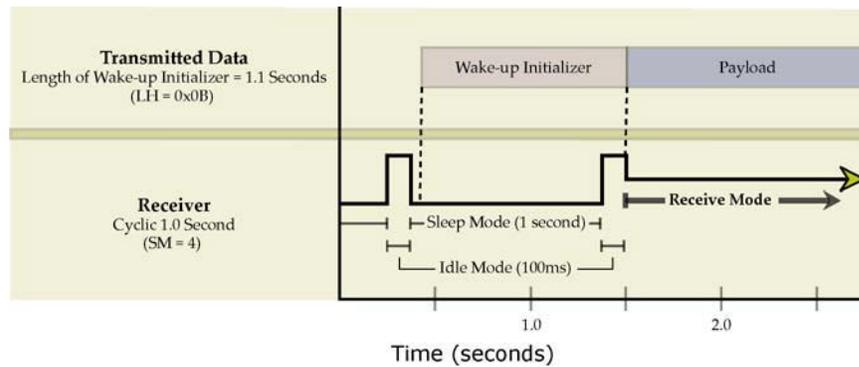
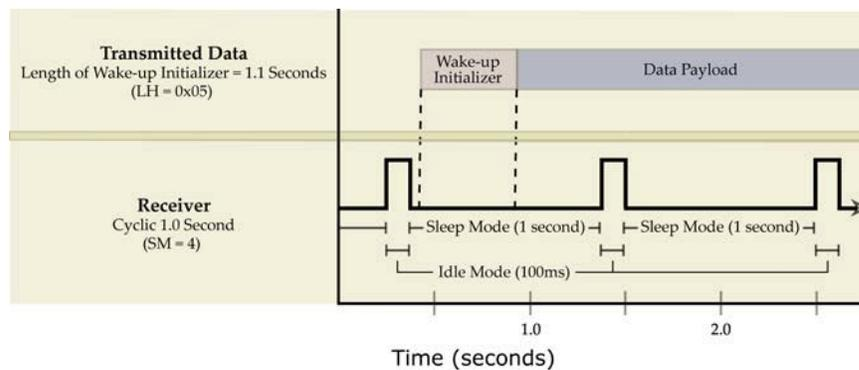

Figure 2-09. Incorrect Configuration (LH < SM)

Length of wake-up initializer is shorter than the time interval of Cyclic Sleep. This configuration is vulnerable to the receiver waking and missing the wake-up initializer (and therefore also the accompanying payload data).



2.2.5. Command Mode

To modify or read module parameters, the module must first enter into Command Mode (a state in which incoming characters are interpreted as commands). Two command types are supported:

- AT Commands
- Binary Commands

AT Commands

To Enter AT Command Mode:

1. Send the 3-character command sequence “+++” and observe guard times before and after the command characters. (Refer to the “Default AT Command Mode Sequence” below.) The “Terminal” tab (or other serial communications software) of the XCTU Software can be used to enter the sequence.
(OR)
2. Assert (low) the $\overline{\text{CONFIG}}$ pin and either turn the power going to the module off and back on. (If using a Digi XIB-R Interface Board, the same result can be achieved by keeping the configuration switch pressed while turning off, then on again the power supplying the module assembly (module assembly = module mounted to an interface board))

Default AT Command Mode Sequence (for transitioning to Command Mode):

- No characters sent for one second (BT (Guard Time Before) parameter = 0x0A)
- Input three plus characters (“+++”) within one second (CC (Command Sequence Character) Command = 0x2B-0)
- No characters sent for one second (AT (Guard Time After) parameter = 0x0A)

To Send AT Commands:

Send AT commands and parameters using the syntax shown below.

Figure 2-10. Syntax for sending AT Commands

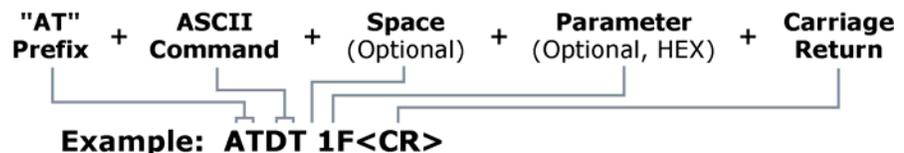

The preceding example would change the module Destination Address to “0x1F”. For modified parameter values to persist in the module registry, changes must be saved to non-volatile memory using WR (Write) Command. Otherwise, parameters are restored to previously saved values after the module is powered off and then on again.

Note: To read the current value of a module parameter, leave the parameter field blank. For example, the following command will return the current destination address: ATDT<CR>

System Response. When a command is sent to the module, the module will parse and execute the command. Upon successful execution of a command, the module returns an “OK” message. If execution of a command results in an error, the module returns an “ERROR” message.

To Exit AT Command Mode:

1. Send ATCN (Exit Command Mode) Command.
(OR)
2. If no valid AT Commands are received within the time specified by CT (Command Mode Timeout) Command, the Module automatically returns to Idle Mode.

For an example that illustrates programming the module using AT Commands, refer to the Module Configuration chapter (p18).

Binary Commands

Sending and receiving parameter values using binary commands is the fastest way to change operating parameters of the module. Binary commands are used most often to sample signal strength (RS parameter) and/or error counts; or to change module addresses and channels for polling systems when a quick response is necessary. Since the sending and receiving of parameter values takes place through the same serial data path as “live” data (received RF payload), interference between the two types of data can be a concern.

Common questions about using binary commands:

What are the implications of asserting CMD while live data is being sent or received?

After sending serial data, is there a minimum time delay before CMD can be asserted?

Is a time delay required after CMD is de-asserted before payload data can be sent?

How does one discern between live data and data received in response to a command?

The CMD pin (pin 5) must be asserted in order to send binary commands to the module. The CMD pin can be asserted to recognize binary commands anytime during the transmission or reception of data. The status of the CMD signal is only checked at the end of the stop bit as the byte is shifted into the serial port. The application does not allow control over when data is received, except by waiting for dead time between bursts of communication.

CMD (pin 5) must be asserted in order to send binary commands to an XStream Module. CMD can be asserted to recognize commands anytime during transmission or reception of data. A minimum time delay of 100 μs (after the stop bit of the command byte has been sent) must be observed before pin 5 can be de-asserted. The command executes after all parameters associated with the command have been sent. If all parameters are not received within 0.5 seconds, the module aborts the command and returns to Idle Mode. **Note:** When parameters are sent, they are always two bytes long with the least significant byte sent first.

Commands can be queried for their current value by sending the command logically ORed with the value 0x80 (hexadecimal) with CMD asserted. When the binary value is sent (with no parameters), the current value of the command parameter is sent back through the DO pin.

Figure 2-11. Binary Command Write then Read
 Signal #4 is CMD (pin 5)
 Signal #1 is the DIN (pin 4) signal to the radio
 Signal #2 is the DOUT (pin 3) signal from the radio
 Signal #3 is CTS (pin 1)

In this graph, a value was written to a register and then read out to verify it. While not in the middle of other received data, note that the CTS signal outlines the data response out of the module.

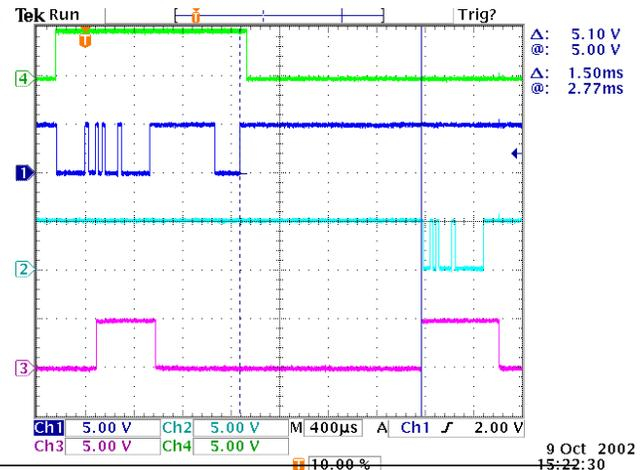

IMPORTANT: For the XStream Module to recognize a binary command, RT (DI2 Configuration) Command must be issued. If binary programming is not enabled (RT ≠ 1), the module will not recognize that the CMD pin (Pin 5) is asserted and therefore will not recognize the data as binary commands.

3. RF Module Configuration

3.1. Hands-on Programming Examples

For information about entering and exiting AT and Binary Command Modes, refer to the Command Mode section (p16).

3.1.1. AT Command Example

To Send AT Commands (Using the Terminal tab of Digi's XCTU Software)

Example: Both of the following examples change the module's destination address to 0x1A0D and save the new address to non-volatile memory.

Method 1 (One line per command)

Send AT Command

```
+++
ATDT <Enter>
ATDT1A0D <Enter>
ATWR <Enter>
ATCN <Enter>
```

System Response

```
OK <CR> (Enter into Command Mode)
current Destination Address <CR> (Read)
OK <CR> (Change destination address)
OK <CR> (Write to non-volatile memory)
OK <CR> (Exit Command Mode)
```

Method 2 (Multiple commands on one line)

Send AT Command

```
+++
ATDT <Enter>
ATDT1A0D,WR,CN <Enter>
```

System Response

```
OK <CR> (Enter into Command Mode)
current Destination Address <CR> (Read)
OK <CR> (Execute commands)
```

Digi's XCTU Software facilitates module programming. To install, double-click the "setup_X-CTU.exe" file that is located at www.digi.com.

Note: In order to use a host PC and the XCTU Software Terminal tab to send data to the module, PC com port settings must match the baud, parity and stop bit parameters stored in the module. Use the "PC Settings" tab to configure PC com port settings to match module parameter values.

3.1.3. Binary Command Example

To Send Binary Commands:

Example: Use binary commands to change the XStream Module's destination address to 0x1A0D and save the new address to non-volatile memory.

1. RT Command must be set to "1" in AT Command Mode to enable binary programming.
2. Assert CMD (Pin 5 is driven high). (Enter Binary Command Mode)
3. Send Bytes (parameter bytes must be 2 bytes long):
 - 00 (Send DT (Destination Address) Command)
 - 0D (Least significant byte of parameter bytes)
 - 1A (Most significant byte of parameter bytes)
 - 08 (Send WR (Write) Command)
4. De-assert CMD (Pin 5 is driven low) (Exit Binary Command Mode)

Note: $\overline{\text{CTS}}$ (pin 1) is de-asserted high when commands are being executed. Hardware flow control must be disabled as $\overline{\text{CTS}}$ will hold off parameter bytes.

3.2. Command Reference Table

Table 3-01. XStream Commands (The module expects numerical values in hexadecimal. “d” denotes decimal equivalent.)

AT Command	Binary Command	AT Command Name	Range	Command Category	# Bytes Returned	Factory Default
AM v4.30*	0x3A (58d)	Auto-set MY	-	Networking and Security	-	-
AT	0x05 (5d)	Guard Time After	0x02 – 0xFFFF (x 100 msec)	Command Mode Options	2	0x0A (10d)
BD v4.2B*	0x15 (21d)	Baud Rate	Standard baud rates: 0 – 6 (custom rates also supported)	Serial Interfacing	2	factory-set RF data rate
BK v4.30*	0x2E (46d)	Serial Break Passing	0 – 1	Serial Interfacing	1	0
BO v4.30*	0x30 (48d)	Serial Break Timeout	0 - 0xFFFF (x 1 second)	Serial Interfacing	2	0
BT	0x04 (4d)	Guard Time Before	0 – 0xFFFF (x 100 msec)	Command Mode Options	2	0x0A (10d)
CB v4.30*	0x33 (51d)	Connection Duration Timeout	0x01 – 0xFFFF (x 100 msec)	Networking and Security	2	0x28 (4d sec)
CC	0x13 (19d)	Command Sequence Character	0x20 – 0x7F	Command Mode Options	1	0x2B (“+”)
CD v4.2B*	0x28 (40d)	DO3 Configuration	0 – 4	Serial Interfacing	1	0
CE v4.30*	0x34 (52d)	Connection Inactivity Timeout	0 – 0xFFFF (x 10 msec)	Networking and Security	2	0x64 (1d sec)
CF v4.30*	0x35 (53d)	Connection Failure Count	0 – 0xFFFF	Networking and Security	2	0
CL v4.30*	0x39 (57d)	Last Connection Address	(read-only)	Diagnostics	2	-
CM v4.30*	0x38 (56d)	Connection Message	0 – 1	Networking and Security	1	0
CN	0x09 (9d)	Exit AT Command Mode	-	Command Mode Options	-	-
CO v4.30*	0x2F (47d)	DO3 Timeout	0 - 0xFFFF (x 1 second)	Serial Interfacing	2	0x03
CS v4.27D*	0x1F (31d)	DO2 Configuration	0 – 4	Serial Interfacing	1	0
CT	0x06 (6d)	Command Mode Timeout	0x02 – 0xFFFF (x 100 msec)	Command Mode Options	2	0xC8 (200d)
DC v4.30*	0x37 (55d)	Disconnect	-	Networking and Security	-	-
DR v4.30*	0x2D (45d)	DI3 Configuration	0 – 4	Serial Interfacing	1	0
DT	0x00 (0d)	Destination Address	0 – 0xFFFF	Networking and Security	2	0
E0	0x0A (10d)	Echo Off	-	Command Mode Options	-	-
E1	0x0B (11d)	Echo On	-	Command Mode Options	-	-
ER	0x0F (15d)	Receive Error Count	0 – 0xFFFF	Diagnostics	2	0
FH	0x0D (13d)	Force Wake-up Initializer	-	Sleep (Low Power)	-	-
FL	0x07 (7d)	Software Flow Control	0 – 1	Serial Interfacing	1	0
FT v4.27B*	0x24 (36d)	Flow Control Threshold	0 – 0xFF (bytes)	Serial Interfacing	2	varies
GD	0x10 (16d)	Receive Good Count	0 – 0xFFFF	Diagnostics	2	0
HP	0x11 (17d)	Hopping Channel	0 – 6	Networking and Security	1	0
HT	0x03 (3d)	Time before Wake-up Initializer	0 – 0xFFFF (x 100 msec)	Sleep (Low Power)	2	0xFFFF
ID v4.2B*	0x27 (39d)	Modem VID	User-settable: 0x10 - 0x7FFF Read-only: 0x8000 – 0xFFFF	Networking and Security	2	-
IU v4.30*	0x3B (59d)	DI2, DI3 Update Timer	0 - 0xFFFF (x 100 msec)	Serial Interfacing	2	0x0A (10d)
LH	0x0C (12d)	Wake-up Initializer Timer	0 – 0xFF (x 100 msec)	Sleep (Low Power)	1	0x01
MD v4.30*	0x32 (50d)	RF Mode	0 – 4	Networking and Security	1	0
MK	0x12 (18d)	Address Mask	0 – 0xFFFF	Networking and Security	2	0xFFFF
MY v4.30*	0x2A (42d)	Source Address	0 – 0xFFFF	Networking and Security	2	0xFFFF
NB v4.30*	0x23 (35d)	Parity	0 – 5	Serial Interfacing	1	0
PC v4.22*	0x1E (30d)	Power-up Mode	0 – 1	Command Mode Options	1	0
PK v4.30*	0x29 (41d)	RF Packet Size	0 - 0x100 (bytes)	Serial Interfacing	2	0x40 (64d)
PW v4.22*	0x1D (29d)	Pin Wake-up	0 – 1	Sleep (Low Power)	1	0
RB v4.30*	0x20 (32d)	Packetization Threshold	0 - 0x100 (bytes)	Serial Interfacing	2	0x01
RE	0x0E (14d)	Restore Defaults	-	(Special)	-	-
RN v4.22*	0x19 (25d)	Delay Slots	0 – 0xFF (slots)	Networking and Security	1	0
RO v4.2A*	0x21 (33d)	Packetization Timeout	0 – 0xFFFF (x 200 µsec)	Serial Interfacing	2	0
RP v4.2A*	0x22 (34d)	RSSI PWM Timer	0 - 0x7F (x 100 msec)	Diagnostics	1	0
RR v4.22*	0x18 (24d)	Retries	0 – 0xFF	Networking and Security	1	0
RS v4.22*	0x1C (28d)	RSSI	0x06 – 0x36 (read-only)	Diagnostics	1	-
RT	0x16 (22d)	DI2 Configuration	0 - 2	Serial Interfacing	1	0
RZ v4.30*	0x2C (44d)	DI Buffer Size	(read-only)	Diagnostics	-	-
SB v4.2B*	0x36 (54d)	Stop Bits	0 - 1	Serial Interfacing	1	0
SH v4.27C*	0x25 (37d)	Serial Number High	0 – 0xFFFF (read-only)	Diagnostics	2	-
SL v4.27C*	0x26 (38d)	Serial Number Low	0 – 0xFFFF (read-only)	Diagnostics	2	-
SM	0x01 (1d)	Sleep Mode	0 – 8	Sleep (Low Power)	1	0
ST	0x02 (2d)	Time before Sleep	0x10 – 0xFFFF (x 100 msec)	Sleep (Low Power)	2	0x64 (100d)
SY	0x17 (23d)	Time before Initialization	0 – 0xFF (x 100 msec)	Networking and Security	1	0 (disabled)
TO v4.30*	0x31 (49d)	DO2 Timeout	0 - 0xFFFF (x 1 sec)	Serial Interfacing	2	0x03
TR v4.22*	0x1B (27d)	Transmit Error Count	0 – 0xFFFF	Diagnostics	2	0
TT v4.22*	0x1A (26d)	Streaming Limit	0 – 0xFFFF (0 = disabled)	Networking and Security	2	0xFFFF
VR	0x14 (20d)	Firmware Version	0 x 0xFFFF (read-only)	Diagnostics	2	-
WR	0x08 (8d)	Write	-	(Special)	-	-

* Firmware version in which command and parameter options were first supported.

Note: AT Commands issued without a parameter value will return the currently stored parameter.

3.3. XStream Command Descriptions

Command descriptions in this section are listed alphabetically. Command categories are designated within “< >” symbols that follow each command title. XStream Modules expect parameter numerical values in hexadecimal (designated by the “0x” prefix).

AM (Auto-set MY) Command

<Networking and Security> AM Command is used to automatically set the MY (Source Address) parameter from the factory-set module serial

number. The address is formed with bits 29, 28 and 13-0 of the serial number (in that order).

AT Command: ATAM
 Binary Command: 0x3A (58 decimal)
 Minimum firmware version required: 4.40

AT (Guard Time After) Command

<Command Mode Options> AT Command is used to set the DI time-of-silence that follows the AT command sequence character (CC Command). By default, AT Command Mode will activate after one second of silence.

Refer to the AT Commands section (p16) to view the default AT Command Mode Sequence.

AT Command: ATAT
 Binary Command: 0x05 (5 decimal)
 Parameter Range: 0x02 – 0xFFFF
 (x 100 milliseconds)
 Number of bytes returned: 2
 Default Parameter Value: 0x0A (10 decimal)
 Related Commands: BT (Guard Time Before), CC (Command Sequence Character)

BD (Interface Data Rate) Command

<Serial Interfacing> BD Command allows the user to adjust the UART interface data rate and thus modify the rate at which serial data is sent to the RF module. The new baud rate does not take effect until the CN command is issued. The RF data rate is unaffected by the BD parameter.

Most applications will require one of the seven standard baud rates; however, non-standard baud rates are also supported.

Note: If the interface data rate is set to exceed the fixed RF data rate of the module, CTS flow control may need to be implemented as described in the Pin Signals (p6), Flow Control (p10) and CS (DO2 Configuration) sections.

Non-standard Interface Data Rates: When parameter values outside the range of standard interface data rates are sent, the closest rate represented by the number is stored in the BD register. For example, a rate of 19200 bps can be set by sending the following command line "ATBD4B00". **Note:** When using Digi's XCTU Software, non-standard interface data rates can only be set and read using the XCTU "Terminal" tab.

When the BD command is sent with a non-standard interface data rate, the UART will adjust to accommodate the requested interface rate. In most cases, the clock resolution will cause the stored BD parameter to vary from the parameter that was sent (refer to the table below). Reading the BD command (send "ATBD" command without an associated parameter value) will return the value that was actually stored in the BD register.

Table 3-02. Parameter Sent vs. Parameter Stored

BD Parameter Sent (HEX)	Interface Data Rate (bps)	BD Parameter Stored (HEX)
0	1200	0
4	19,200	4
7	115,200	7
12C	300	12B
1C200	115,200	1B207

AT Command: ATBD
 Binary Command: 0x15 (21 decimal)
 Parameter Range (Standard baud rates): 0 – 6
 (Non-standard baud rates): 0x7D – 0xFFFF

Parameter	Configuration (bps)
0	1200
1	2400
2	4800
3	9600
4	19200
5	38400
6	57600

Number of bytes returned: 2
 Default Parameter Value: Set to equal module's factory-set RF data rate.
 Related Commands: CN (Exit Command Mode)
 Minimum firmware version required: 4.2B
 (Custom baud rates not previously supported.)

BK (Serial Break Passing) Command

<Serial Interfacing> Pass a serial break condition on the DI pin to the DO pin of another module.

AT Command: ATBK

Binary Command: 0x2E (46 decimal)

Parameter Range: 0 – 1

Parameter	Configuration
0	disable
1	enable

Default Parameter Value: 0

Number of bytes returned: 1

Related Commands: BO (Serial Break Timeout)

Minimum Firmware Version Required: 4.30

BO (Serial Break Timeout) Command

<Serial Interfacing> DO pin will return to default after no serial break status information is received during the timeout period.

Use with BK parameter = 1.

AT Command: ATBO

Binary Command: 0x30 (48 decimal)

Parameter Range: 0 – 0xFFFF (x 1 second)

Default Parameter Value: 0

Number of bytes returned: 2

Related Commands: BK (Serial Break Passing)

Minimum Firmware Version Required: 4.30

BT (Guard Time Before) Command

<Command Mode Options> BT Command is used to set the DI pin silence time that must precede the command sequence character (CC Command) of the AT Command Mode Sequence.

Refer to the AT Commands section (p16) to view the default AT Command Mode sequence.

AT Command: ATBT

Binary Command: 0x04 (4 decimal)

Parameter Range: 0 – 0xFFFF (x 100 milliseconds)

Default Parameter Value: 0x0A (10 decimal)

Number of bytes returned: 2

Related Commands: AT (Guard Time After), CC (Command Sequence Character)

CB (Connection Duration Timeout) Command

<Networking and Security> Set/Read the maximum amount of time an exclusive connection between a base and remote module in a point-to-multipoint network is sustained. The remote module will disconnect when this timeout expires.

AT Command: ATCB

Binary Command: 0x33 (51 decimal)

Parameter Range: 0x01 – 0xFFFF (x 100 milliseconds)

Default Parameter Value: 0x28 (4d seconds)

Number of bytes returned: 2

Related Commands: CE (Connection Inactivity Timeout), DC (Disconnect), MD (RF Mode)

Minimum Firmware Version Required: 4.30

CC (Command Sequence Character) Command

<Command Mode Options> CC Command is used to set the ASCII character to be used between Guard Times of the AT Command Mode Sequence (BT+ CC + AT). The AT Command Mode Sequence activates AT Command Mode (from Idle Mode).

Refer to the AT Commands section (p16) to view the default AT Command Mode sequence.

AT Command: ATCC

Binary Command: 0x13 (19 decimal)

Parameter Range: 0x20 – 0x7F

Default Parameter Value: 0x2B (ASCII “+” sign)

Number of bytes returned: 1

Related Commands: AT (Guard Time After), BT (Guard Time Before)

CD (DO3 Configuration) Command

<Serial Interfacing> CD Command is used to redefine the behavior of the DO3 (Data Output 3)/RX LED line.

<u>AT Command: ATCD</u>	
<u>Binary Command: 0x28 (40 decimal)</u>	
<u>Parameter Range: 0 – 4</u>	
<u>Parameter</u>	<u>Configuration</u>
<u>0</u>	<u>RX LED</u>
<u>1</u>	<u>Default high</u>
<u>2</u>	<u>Default low</u>
<u>3</u>	<u>(reserved)</u>
<u>4</u>	<u>Assert only when packet addressed to module sent</u>
<u>Default Parameter Value: 0</u>	
<u>Number of bytes returned: 1</u>	
<u>Minimum Firmware Version Required: 4.2B</u>	

CE (Connection Inactivity Timeout) Command

<Networking and Security> Set/Read the duration of inactivity that will cause a break in a connection between modules. The base module will disconnect when no payload has been transferred for the time specified by the CE parameter.

<u>AT Command: ATCE</u>	
<u>Binary Command: 0x34 (52 decimal)</u>	
<u>Parameter Range: 0 – 0xFFFF</u> <u>(x 10 milliseconds)</u>	
<u>Default Parameter Value: 0x64 (1 d second)</u>	
<u>Number of bytes returned: 2</u>	
<u>Related Commands: CB (Connection Duration Timeout), DC (Disconnect), MD (RF Mode)</u>	
<u>Minimum Firmware Version Required: 4.30</u>	

CF (Connection Failure Count) Command

<Diagnostics> Set/Read the number of times the base module expired retries attempting to send a Connection Grant Packet. Set to zero to clear the register.

<u>AT Command: ATCF</u>	
<u>Binary Command: 0x35 (53 decimal)</u>	
<u>Parameter Range: 0 – 0xFFFF</u>	
<u>Default Parameter Value: 0</u>	
<u>Number of bytes returned: 2</u>	
<u>Minimum Firmware Version Required: 4.30</u>	

CL (Last Connection Address) Command

<Diagnostics/Networking and Security> Read the address of the remote module that last connected to the base module. A remote module will return its DT (Destination Address) parameter.

<u>AT Command: ATCL</u>	
<u>Binary Command: 0x39 (57 decimal)</u>	
<u>Parameter Range: 0 – 0xFFFF (read-only)</u>	
<u>Number of bytes returned: 2</u>	
<u>Minimum Firmware Version Required: 4.30</u>	

CM (Connection Message) Command

<Networking and Security> Select whether base sends connect messages to the host when a connection is established. When enabled, a “CONNECTXXXX” string is sent to the host of the base module. “XXXX” is the MY (Source Address) of the connected remote module.

<u>AT Command: ATCM</u>	
<u>Binary Command: 0x38 (56 decimal)</u>	
<u>Parameter Range: 0 – 1</u>	
<u>Parameter</u>	<u>Configuration</u>
<u>0</u>	<u>enable</u>
<u>1</u>	<u>disable</u>
<u>Default Parameter Value: 0</u>	
<u>Number of bytes returned: 1</u>	
<u>Minimum Firmware Version Required: 4.30</u>	

CN (Exit AT Command Mode) Command

<Command Mode Options> CN Command is used to explicitly exit AT Command Mode.

AT Command: ATCN
Binary Command: 0x09 (9 decimal)

CO (DO3 Timeout) Command

<Serial Interfacing> DO3 (Data Output 3) output will return to default after no DI3 (Data Input 3) status information is received during the timeout period.

Use with CD = 1 or 2, DR = 1.

AT Command: ATCO
Binary Command: 0x2F (47 decimal)
Parameter Range: 0 - 0xFFFF (x 1 second)
Default Parameter Value: 3
Number of bytes returned: 2
Related Commands: CD (DO3 Configuration), DR (DI3 Configuration)
Minimum Firmware Version Required: 4.30

CS (DO2 Configuration) Command

<Serial Interfacing> CS Command is used to select the behavior of the DO2 (Data Output 2) pin signal. This output can provide RS-232 flow control, control the TX enable signal (for RS-485 or RS-422 operations), or set the default level for the I/O line passing function.

By default, DO2 provides RS-232 $\overline{\text{CTS}}$ (Clear-to-Send) flow control.

AT Command: ATCS
Binary Command: 0x1F (31 decimal)

Parameter Range: 0 - 4

Parameter	Configuration
0	RS-232 $\overline{\text{CTS}}$ flow control
1	RS-485 TX enable low
2	high
3	RS-485 TX enable high
4	low

Default Parameter Value: 0
Number of bytes returned: 1
Related Commands: RT (DI2 Configuration), TO (DO2 Timeout)
Minimum Firmware Version Required: 4.27D

CT (Command Mode Timeout) Command

<Command Mode Options> CT Command is used to set the amount of time of inactivity before AT Command Mode automatically terminates. After a CT time of inactivity, the module exits AT Command Mode and returns to Idle Mode. AT Command Mode can also be exited manually using the CN (Exit AT Command Mode) Command.

AT Command: ATCT
Binary Command: 0x06 (6 decimal)
Parameter Range: 2 - 0xFFFF (x 100 milliseconds)
Default Parameter Value: 0xC8 (200 decimal, 20 seconds)
Number of bytes returned: 2

DC (Disconnect) Command

<Networking and Security> DC Command is used (when in Multi-Streaming Mode (MD = 1 or 2)) to explicitly force the disconnection of an active exclusive connection. If MD = 1, the base module will force the disconnection of an exclusive connection. If MD = 2, the remote module will send a "Disconnect Request Packet" to the base module.

AT Command: ATDC
Binary Command: 0x37 (55 decimal)
Related Commands: CB (Connection Duration Timeout), CE (Connection Inactivity Timeout), MD (RF Mode)
Minimum Firmware Version Required: 4.30

DR (DI3 Configuration) Command

<Serial Interfacing> DR Command is used to configure DI3 (pin 2, SLEEP) for I/O line passing (use with CD = 1 or 2 and CO) or controlling connection status (use with MD = 1 or 2).

AT Command: ATDR

Binary Command: 0x2D (45 decimal)

Parameter Range: 0 - 4

Parameter	Configuration
0	Disabled
1	DI3 I/O passing enabled
2	Connect on low
3	Disconnect on high
4	Connect and Disconnect

Default Parameter Value: 0

Number of bytes returned: 1

Related Commands: CD (DO3 Configuration), CO (DO3 Timeout), MD (RF Mode)

Minimum Firmware Version Required: 4.30

DT (Destination Address) Command

<Networking and Security> DT Command is used to set the networking address of an XStream Module. XStream Modules use three filtration layers: Channels (ATHP), Vendor Identification Number (ATID) and Destination Addresses (ATDT). DT Command assigns an address to a module that enables it to communicate only with other modules having the same addresses. All

modules that share the same Destination Address can communicate freely with each other. Modules in the same network with a different Destination Address (than that of the transmitter) will listen to all transmissions to stay synchronized, but will not send any of the data out their serial ports.

AT Command: ATDT

Binary Command: 0x00

Parameter Range: 0 - 0xFFFF

Default Parameter Value: 0

Number of bytes returned: 2

Related Commands: HP (Hopping Channel), ID (Module VID), MK (Address Mask)

E0 (Echo Off) Command

<Command Mode Options> The E0 command turns off character echo in AT Command Mode. By default, echo is off.

AT Command: ATE0

Binary Command: 0x0A (10 decimal)

E1 (Echo On) Command

<Command Mode Options> E1 Command turns on the echo in AT Command Mode. Each typed character will be echoed back to the terminal when ATE1 is active. E0 is the default.

AT Command: ATE1

Binary Command: 0x0B (11 decimal)

ER (Receive Error Count) Command

<Diagnostics> Set/Read the receive error count. The error-count records the number of packets partially received then aborted on reception error. This value returns to 0 after a reset and is not non-volatile (value does not persist in the module's memory after a power-up sequence). Once the receive error count reaches its maximum value (up to 0xFFFF), it remains at its maximum count value until the maximum count value is explicitly changed or the module is reset.

AT Command: ATER

Binary Command: 0x0F (15 decimal)

Parameter Range: 0 - 0xFFFF

Default Parameter Value: 0

Number of bytes returned: 2

Related Commands: GD (Receive Good Count)

FH (Force Wake-up Initializer) Command

<Sleep (Low Power)> FH Command is used to force a Wake-up Initializer to be sent on the next transmission. WR (Write) Command does not need to be issued with FH Command.

AT Command: ATFH
 Binary Command: 0x0D (13 decimal)

Use only with cyclic sleep modes active on remote modules.

FL (Software Flow Control) Command

<Serial Interfacing> FL Command is used to configure of module with software flow control. Hardware flow control is implemented with the XStream Module as the DO2 pin (\overline{CTS}), which regulates when serial data can be transferred to the module. FL Command is used to allow software flow control. XON character used is 0x11 (17 decimal). XOFF character used is 0x13 (19 decimal).

AT Command: ATFL
 Binary Command: 0x07 (7 decimal)

Parameter Range: 0 - 1

Parameter	Configuration
0	Disable software flow control
1	Enable software flow control

Default Parameter Value: 0
 Number of bytes returned: 1

FT (Flow Control Threshold) Command

<Serial Interfacing> Set/Read the flow control threshold. When FT bytes have accumulated in the DI buffer, \overline{CTS} is de-asserted or the XOFF software flow control character is transmitted.

AT Command: ATFT
 Binary Command: 0x24 (36 decimal)
 Parameter Range: 0 - 0xFF (bytes)
 (Maximum value equals the receiving module DO buffer size minus 0x11 bytes)

Default Parameter Value: Receiving module DO Buffer size minus 0x11

Number of bytes returned: 2
 Minimum Firmware Version Required: 4.27B

GD (Receive Good Count) Command

<Diagnostics> Set/Read the count of good received RF packets. Parameter value is reset to 0 after every reset and is not non-volatile (value does not persist in the module's memory after a power-up sequence). Once the "Receive Good Count" reaches its maximum value (up to 0xFFFF), it remains at its maximum count value until the maximum count value is manually changed or the module is reset.

AT Command: ATGD
 Binary Command: 0x10 (16 decimal)
 Parameter Range: 0 - 0xFFFF
 Default Parameter Value: 0
 Number of bytes returned: 2
 Related Commands: ER (Receive Error Count)

HP (Hopping Channel) Command

<Networking and Security> HP Command is used to set the module hopping channel number. A channel is one of three layers of addressing available to the module. In order for modules to communicate with each other, the modules must have the same channel number since each network uses a different hopping sequence. Different channels can be used to prevent modules in one network from listening to transmissions of another.

AT Command: ATHP
 Binary Command: 0x11 (17 decimal)
 Parameter Range: 0 - 6
 Default Parameter Value: 0
 Number of bytes returned: 1
 Related Commands: DT (Destination Address), ID (Module VID), MK (Address Mask)

HT (Time before Wake-up Initializer) Command

<Sleep (Low Power)> If any modules within range are running in a “Cyclic Sleep” setting, a wake-up initializer must be used by the transmitting module for sleeping modules to remain awake (refer to the LH (“Wake-up Initializer Timer”) Command). When a receiving module in Cyclic Sleep wakes, it must detect the wake-up initializer in order to remain awake and receive data. The value of HT Parameter tells the transmitter, “After a period of inactivity (no transmitting or receiving) lasting HT amount of time, send a long wake-up initializer”. HT Parameter should be set to match the inactivity timeout (specified by ST (Time before Sleep) Command) used by the receiver(s).

From the receiving module perspective, after HT time elapses and the inactivity timeout (ST command) is met, the receiver goes into cyclic sleep. In cyclic sleep, the receiver wakes once per sleep interval to check for a wake-up initializer. When a wake-up initializer is detected, the module will stay awake to receive data. The wake-up initializer must be longer than the cyclic sleep interval to ensure that sleeping modules detect incoming data. When HT time elapses, the transmitter then knows that it needs to send a long Wake-up Initializer for all receivers to be able to remain awake and receive the next transmission. Matching HT to the time specified by ST on the receiving module guarantees that all receivers will detect the next transmission.

AT Command: ATHT

Binary Command: 0x03 (3 decimal)

Parameter Range: 0 – 0xFFFF
(x 100 milliseconds)

Default Parameter Value: 0xFFFF (means that long wake-up initializer will not be sent)

Number of bytes returned: 2

Related Commands: LH (Wake-up Initializer Timer), SM (Sleep Mode), ST (Time before Sleep)

ID (Modem VID) Command

<Networking and Security> Set/Read the VID (Vendor Identification Number). Only modules with matching VIDs can communicate with each other. Modules with non-matching VIDs will not receive unintended data transmission.

AT Command: ATID

Binary Command: 0x27 (39 decimal)

Parameter Range (user-settable):
0x10 – 0x7FFFF

(Factory-set and read-only):
0x8000 – 0xFFFF

Number of bytes returned: 2

Minimum Firmware Version Required: 4.2B
(previous firmware versions did not support user-settable IDs.)

IU (DI2, DI3 Update Timer) Command

<Serial Interfacing> Set/Read the interval at which the status of DI2, DI3 and Break is transmitted. Additionally, status is transmitted whenever there is a transition. A setting of “0” disables periodic update. DI2 or DI3 passing must be enabled for the update to take place.

AT Command: ATIU

Binary Command: 0x3B (59 decimal)

Parameter Range: 0 – 0xFFFF (x 100 ms)

Default Parameter Value: 0x0A (10 decimal)

Number of bytes returned: 2

Related Commands: BK (Serial Break Passing), BO (Serial Break Timeout), CO (DO3 Timeout), DR (Disconnect), RT (DI2 Configuration), TO (DO2 Timeout)

Minimum Firmware Version Required: 4.30

LH (Wake-up Initializer Timer) Command

<Sleep (Low Power) > Set/Read the amount of time during which the RF initializer is sent. When receiving modules are put into Cyclic Sleep Mode, they power-down after a period of inactivity (specified by ST (Time before Sleep) Command) and will periodically awaken and listen for transmitted data. In order for the receiving modules to remain awake, they must detect ~35ms of the wake-up initializer.

LH Command must be used whenever a receiver is operating in Cyclic Sleep Mode. This lengthens the Wake-up Initializer to a specific amount of time (in tenths of a second). The Wake-up Initializer Time must be longer than the cyclic sleep time that is determined by SM (Sleep Mode) Command. If the wake-up initializer time were less than the Cyclic Sleep interval, the connection would be at risk of missing the wake-up initializer transmission.

Refer to the figures in the Sleep Mode sections (p13) to view correct and incorrect configuration diagrams. The images help visualize the importance that the LH value be greater than the SM cyclic sleep value.

AT Command: ATLH
 Binary Command: 0x0C (12 decimal)
 Parameter Range: 0 – 0xFF
 (x 100 milliseconds)
 Default Parameter Value: 1
 Number of bytes returned: 1
 Related Commands: HT (Time before Wake-up Initializer), SM (Sleep Mode), ST (Time before Sleep)

MD (RF Mode) Command

<Networking and Security> The MD command is used to select/read the RF Mode (Peer-to-peer, Multi-Stream or Repeater Modes) of the module.

Multi-Streaming Mode enables exclusive connections in point-to-multipoint networks. Refer to the Multi-Streaming Mode section (p43) for more information regarding how these parameter values affect other parameter values.

Repeater Mode enables longer range via an intermediary module. When MD=3, the module will act as a “store and forward” repeater. Any packets not addressed to this node will be repeated. A Repeater End Node (MD=4) handles repeated messages, but will not forward the data over-the-air. Refer to the Repeater Mode section (p38) for more information.

AT Command: ATMD
 Binary Command: 0x32 (50 decimal)
 Parameter Range: 0 – 4

Parameter	Configuration
0	Peer-to-Peer (transparent operation)
1	Multi-Stream Base
2	Multi-Stream Remote
3	Repeater and End Node
4	End Node

Default Parameter Value: 0
 Number of bytes returned: 1
 Related Commands: CB (Connection Duration Timeout), CE (Connection Inactivity Timeout), CM (Connection Message), DC (Disconnect)
 Minimum Firmware Version Required: 4.30

MK (Address Mask) Command

<Networking and Security> MK Command is used to set/read the address mask of the module.

All data packets contain the destination address (DT Parameter) of the transmitting module. When an RF data packet is received, the transmitter’s destination address is logically “ANDed” (bitwise) with the Address Mask of the receiver. The resulting value must match the destination address or the address mask of the receiver for the packet to be received and sent out the module DO serial port. If the “ANDed” value does not match either the destination address or the address mask of the receiver, the packet is discarded. (All “0” values are treated as “irrelevant” values and are ignored.)

Refer to the Addressing Options section (p36) for more information.

AT Command: ATMK
 Binary Command: 0x12 (18 decimal)
 Parameter Range: 0 – 0xFFFF
 Default Parameter Value: 0xFFFF
 (Destination address (DT parameter) of the transmitting module must exactly match the destination address of the receiving module.)
 Number of bytes returned: 2
 Related Commands: DT (Destination Address), HP (Hopping Channel), ID (Module VID), MY (Source Address)

MY (Source Address) Command

<Networking and Security> Set/Read the source address of the module.

Refer to the Addressing section (p36) of the RF Communication Modes chapter for more information.

AT Command: ATMY

Binary Command: 0x2A (42 decimal)

Parameter Range: 0 – 0xFFFF

Default Parameter Value: 0xFFFF (Disabled – the DT (Destination Address) parameter serves as both source and destination address.)

Number of bytes returned: 2

Related Commands: DT (Destination Address), HP (Hopping Channel), ID (Modem VID), MK (Address Mask), AM (Auto-set MY)

Minimum Firmware Version Required: 4.30

NB (Parity) Command

<Serial Interfacing> Select/Read parity settings for UART communications.

AT Command: ATNB

Binary Command: 0x23 (35 decimal)

Parameter Range: 0 – 5

Parameter	Configuration
0	8-bit (no parity or 7-bit (any parity))
1	8-bit even
2	8-bit odd
3	8-bit mark
4	8-bit space
5	9-bit

Default Parameter Value: 0

Number of bytes returned: 1

Minimum Firmware Version Required: 4.30 (previous versions did not support the 9th bit.)

PC (Power-up Mode) Command

<Command Mode Options> PC Command allows the module to power-up directly into AT Command Mode from reset or power-on. If PC Command is enabled with SM Parameter set to 1, DI3 (pin 2) can be used to enter the module into AT Command Mode. When the DI3 pin is de-asserted (low), the module will wake-up in AT Command Mode. This behavior allows module DTR emulation.

AT Command: ATPC

Binary Command: 0x1E (30 decimal)

Parameter Range: 0 – 1

Parameter	Configuration
0	Power-up to Idle Mode
1	Power-up to AT Command Mode

Default Parameter Value: 0

Number of bytes returned: 1

Minimum Firmware Version Required: 4.22

PK (RF Packet Size) Command

<Serial Interfacing> Set/Read the maximum size of the RF packets sent out a transmitting module. The maximum packet size can be used along with the RB and RO parameters to implicitly set the channel dwell time.

Changes to this parameter may have a secondary effect on the RB (Packet Control Characters) parameter. RB must always be less than or equal to PK. If PK is changed to a value less than the current value of RB, RB is automatically lowered to be equal to PK.

AT Command: ATPK

Binary Command: 0x29 (41 decimal)

Parameter Range: 0 – 0x100 (Bytes)

Default Parameter Value: 0x40 (64 decimal)

Number of bytes returned: 2

Related Commands: RB (Packetization Threshold), RO (Packetization Timeout)

Minimum Firmware Version Required: 4.30

PW (Pin Wake-up) Command

<Sleep (Low Power)> Under normal operation, a module in Cyclic Sleep Mode cycles from an active state to a low-power state at regular intervals until data is ready to be received. If the PW Parameter is set to 1, SLEEP (pin 2) can be used to wake the module from Cyclic Sleep. If the SLEEP pin is de-asserted (low), the module will be fully operational and will not go into Cyclic Sleep. Once SLEEP is asserted, the module will remain active for the period of time specified by ST (Time before Sleep) Command and will return to Cyclic Sleep Mode (if no data is ready to be transmitted). PW Command is only valid if Cyclic Sleep has been enabled.

AT Command: ATPW

Binary Command: 0x1D (29 decimal)

Parameter Range: 0 - 1

Parameter	Configuration
0	Disabled
1	Enabled

Default Parameter Value: 0

Number of bytes returned: 1

Related Commands: SM (Sleep Mode), ST (Time before Sleep)

Minimum Firmware Version Required: 4.22

RB (Packetization Threshold) Command

<Serial Interfacing> RF transmission will commence when data is in the DI Buffer and either of the following criteria are met:

- RO times out on the UART receive lines (ignored if RO = 0)
- RB characters have been received by the UART (ignored if RB = 0)

If PK is lowered below the value of RB; RB is automatically lowered to match PK.

Note: RB and RO criteria only apply to the first packet of a multi-packet transmission. If data remains in the DI Buffer after the first packet, transmissions will continue in streaming manner until there is no data left in the DI Buffer (UART receive buffer).

AT Command: ATRB

Binary Command: 0x20 (32 decimal)

Parameter Range: 0 - 0x100 (bytes) (Maximum value equals the current value of PK Parameter (up to 0x100 HEX (800 decimal)))

Default Parameter Value: 1

Number of bytes returned: 2

Related Commands: PK (RF Packet Size), RO (Packetization Timeout)

Minimum Firmware Version Required: 4.30

RE (Restore Defaults) Command

<Diagnostics> RE Command restores all configurable parameters to factory default settings. However, RE Command will not write the restored values to non-volatile (persistent) memory. Issue the WR (Write) Command after the RE command to save restored parameter values to non-volatile memory.

AT Command: ATRE

Binary Command: 0x0E (14 decimal)

RN (Delay Slots) Command

<Networking and Security> RN Command is only applicable if retries have been enabled (RR (Retries) parameter > 0), or if forced delays will be inserted into a transmission (TT (Streaming Limit) parameter > 0). RN Command is used to adjust the time delay that the transmitter inserts before attempting to resend a packet. If the transmitter fails to receive an acknowledgement after sending a packet, it will insert a random number of delay slots (ranging from 0 to (RN minus 1)) before attempting to resend the packet. Each delay slot lasts for a period of 38ms. If two modules attempted to transmit at the same time, the random time delay after packet failure would allow one of the two modules to transmit the packet successfully, while the other would wait until the channel opens up to begin transmission.

AT Command: ATRN

Binary Command: 0x19 (25 decimal)

Parameter Range: 0 - 0xFF (slots)

Default Parameter Value: 0 (no delay slots are inserted)

Number of bytes returned: 1

Related Commands: RR (Retries), TT (Streaming Limit)

Minimum Firmware Version Required: 4.22

RO (Packetization Timeout) Command

<Serial Interfacing> Set/Read the time of silence (no bytes received) after which transmission begins. After a serial byte is received and if no other byte is received before the RO timeout, the transmission will start.

AT Command: ATRO
 Binary Command: 0x21 (33 decimal)
 Parameter Range: 0 – 0xFFFF (x 200 μs)
 Default Parameter Value: 0
 Number of bytes returned: 2
 Minimum Firmware Version Required: 4.2A

RP (RSSI PWM Timer) Command

<Diagnostics> RP Command is used to enable PWM (Pulse Width Modulation) output on the CONFIG pin. The output is calibrated to show the level the received RF signal is above the sensitivity level of the module. The PWM pulses vary from zero to 95 percent. Zero percent means the received RF signal is at or below the published sensitivity level of the module. The following table shows levels above sensitivity and PWM values.

AT Command: ATRP
 Binary Command: 0x22 (34 decimal)
 Parameter Range: 0 – 0x7F (x 100 milliseconds)
 Default Parameter Value: 0 (disabled)
 Number of bytes returned: 1
 Minimum Firmware Version Required: 4.2A

The total period of the PWM output is 8.32 ms. Because there are 40 steps in the PWM output; the minimum step size is 0.208 ms.

Table 3-03. PWM Chart

dBm above Sensitivity	PWM percentage (high period / total period)
10	47.5%
20	62.5%
30	77.5%

A non-zero value defines the time that the PWM output will be active with the RSSI value of the last received RF packet. After the set time when no RF packets are received, the PWM output will be set low (0 percent PWM) until another RF packet is received. The PWM output will also be set low at power-up. A parameter value of 0xFF permanently enables the PWM output and it will always reflect the value of the last received RF packet.

PWM output shares the Config input pin. When the module is powered, the Config pin will be an input. During the power-up sequence, the Config pin will be read to determine whether the module is going into AT Command Mode. After this, if RP parameter is a non-zero value, the Config pin will be configured as an output and set low until the first RF packet is received. With a non-zero RP parameter, the Config pin will be an input for RP ms after power up.

RR (Retries) Command

<Networking> Set/Read the number of retries that can be sent for a given RF packet. Once RR command is enabled (set to a non-zero value), RF packet acknowledgements and retries are enabled. After transmitting a packet, the transmitter will wait to receive an acknowledgement from a receiver. If the acknowledgement is not received in the period of time specified by the RN (Delay Slots) Command, the transmitter will transmit the original packet again. The packet will be transmitted repeatedly until an acknowledgement is received or until the packet has been sent RR times.

AT Command: ATRR
 Binary Command: 0x18 (24 decimal)
 Parameter Range: 0 – 0xFF
 Default Parameter Value: 0 (disabled)
 Number of bytes returned: 1
 Minimum Firmware Version Required: 4.22

Note: For retries to work correctly, all modules in the system must have retries enabled.

RS (RSSI) Command

<Diagnostics> Read the signal level of the last packet received. This reading is useful for determining range characteristics of the modules under various conditions of noise and distance.

Once the command is issued, the module will return a value between 0x06 and 0x36. (“0x36” represents a very strong signal level and “0x06” indicates a low signal level.)

AT Command: ATRS

Binary Command: 0x1C (28 decimal)

Parameter Range: 0x06 – 0x36 (read-only)

Number of bytes returned: 1

Minimum Firmware Version Required: 4.22

RT (DI2 Configuration) Command

<Serial Interfacing> RT command is used to dictate the behavior of the DI2/ $\overline{\text{RTS}}$ /CMD line. RT Command must be issued to enable $\overline{\text{RTS}}$ flow control or binary programming.

AT Command: ATRT

Binary Command: 0x16 (22 decimal)

Parameter Range: 0 – 2

Parameter	Configuration
0	disabled
1	Enable Binary Programming
2	Enable $\overline{\text{RTS}}$ Flow Control

Default Parameter Value: 0

Number of bytes returned: 1

RZ (DI Buffer Size) Command

<Diagnostics> The RZ command is used to read the size of the DI buffer (UART RX (Receive)).

Note: The DO buffer size can be determined by multiplying the DI buffer size by 1.5.

AT Command: ATRZ

Binary Command: 0x2C (44 decimal)

Parameter Range: Read-only

Number of bytes returned: 2

Minimum Firmware Version Required: 4.30

SB (Stop Bits) Command

<Serial Interfacing> Set/Read the number of stop bits in the RF data packets.

AT Command: ATSB

Binary Command: 0x36 (54 decimal)

Parameter Range: 0 – 1

Parameter	Configuration
0	1 stop bits
1	2 stop bits

Default Parameter Value: 0

Number of bytes returned: 1

Minimum Firmware Version Required: 4.2B

SH (Serial Number High) Command

<Diagnostics> Set/Read the serial number high word of the module.

AT Command: ATSH

Binary Command: 0x25 (37 decimal)

Parameter Range: 0 – 0xFFFF (read-only)

Number of bytes returned: 2

Related Commands: SL (Serial Number Low)

Minimum Firmware Version Required: 4.27C

SL (Serial Number Low) Command

<Diagnostics> Set/Read the serial number low word of the module.

AT Command: ATSH
 Binary Command: 0x26 (38 decimal)
 Parameter Range: 0 - 0xFFFF (read-only)
 Number of bytes returned: 2
 Related Commands: SH (Serial Number High)
 Minimum Firmware Version Required: 4.27C

SM (Sleep Mode) Command

<Sleep Mode (Low Power)> Set/Read Sleep Mode Settings. By default, Sleep Mode is disabled and the module remains continually active.

SM Command allows the module to run in a lower-power state and to be configured in one of eight settings.

Cyclic Sleep settings wake the module after the amount of time designated by SM Command. If the module detects a wake-up initializer during the time it is awake, it will synchronize with the transmitter and start receiving data after the wake-up initializer runs its duration. Otherwise, it returns to Sleep Mode and continues to cycle in and out of inactivity until the Wake-up Initializer is detected. If a Cyclic Sleep setting is chosen, the ST, LH and HT parameters must also be set as described in the “Sleep Mode” section of this manual.

Refer to the Sleep Mode sections for more information.

AT Command: ATSM
 Binary Command: 0x01
 Parameter Range: 0 - 8

Parameter	Configuration
0	Disabled
1	Pin Sleep
2	Serial Port Sleep
3	Cyclic 0.5 second sleep (Module wakes every 0.5 seconds)
4	Cyclic 1.0 second sleep
5	Cyclic 2.0 second sleep
6	Cyclic 4.0 second sleep
7	Cyclic 8.0 second sleep
8	Cyclic 16.0 second sleep

Default Parameter Value: 0
 Number of bytes returned: 1
 Related Commands:
 Pin Sleep – PC (Power-up Mode), PW (Pin Wake-up)
 Serial Port Sleep – ST (Time before Sleep)
 Cyclic Sleep – ST (Time before Sleep), LH (Wake-up Initializer Timer), HT (Time Before Wake-up Initializer), PW (Pin Wake-up)

ST (Time before Sleep) Command

<Sleep Mode (Low Power)> Set/Read the period of time in which the module remains inactive before entering into Sleep Mode. For example: If the ST parameter is set to 0x64 (100 decimal), the module will enter into Sleep mode after 10 seconds of inactivity (no transmitting or receiving). This command can only be used if Cyclic Sleep or Serial Port Sleep Mode settings have been selected using the SM command.

AT Command: ATST
 Binary Command: 0x02
 Parameter Range: 0x10 - 0xFFFF (x 100 milliseconds)
 Default Parameter Value: 0x64 (100 decimal)
 Number of bytes returned: 2
 Related Commands: SM (Sleep Mode), LH (Wake-up Initializer Timer), HT (Time before Wake-up Initializer)

SY (Time before Initialization) Command

<Networking and Security> SY Command keeps a communication channel open as long as module transmits or receives before the active connection expires. It can be used to reduce latency in a query/response sequence and should be set 100 ms longer than the delay between transmissions.

This command allows multiple XStream Modules

to share a hopping channel for a given amount of time after receiving data. By default, all packets include an RF initializer that contains channel information used to synchronize any listening receivers to the transmitter’s hopping pattern. Once a new module comes within range, it is able to instantly synchronize to the transmitter and start receiving data. If no new modules are introduced into the system, the synchronization information becomes redundant once modules have become synchronized.

SY Command allows the modules to remove this information from the RF Initializer after the initial synchronization. For example, changing the SY Parameter to 0x14 (20 decimal) allows all modules to remain in sync for 2 seconds after the last data packet was received. Synchronization information is not re-sent unless transmission stops for more than 2 seconds. This command allows significant savings in packet transmission time.

AT Command: ATSY
Binary Command: 0x17 (23 decimal)
Parameter Range: 0 – 0xFF
(x 100 milliseconds)
Default Parameter Value: 0 (Disabled – channel initialization info sent with each RF packet.)
Number of bytes returned: 1

Warning: Not recommended for use in an interference-prone environment. Interference can break up the session and the communications channel will not be available again until SY time expires.

With SY set to zero, the channel session is opened and closed with each transmission - resulting in a more robust link with more latency.

TO (DO2 Timeout) Command

<Serial Interfacing>DO2 output will return to default after no D12 status information is received during the timeout period.

Use with CS = 2 or 4.

AT Command: ATTO
Binary Command: 0x31 (49 decimal)
Parameter Range: 0 – 0xFFFF (x 1 second)
Default Parameter Value: 3
Number of bytes returned: 2
Minimum Firmware Version Required: 4.30

TR (Transmit Error Count) Command

<Diagnostics> Read number of retransmit failures. The number of retransmit errors is incremented each time a packet is not acknowledged within the number of retransmits specified by the RR (Retries) parameter. It therefore counts the number of packets that were not successfully received and have been dropped.

The TR parameter is not non-volatile and therefore is reset to zero each time the module is reset.

AT Command: ATTR
Binary Command: 0x1B (27 decimal)
Parameter Range: 0 – 0xFFFF
Default Parameter Value: 0
Number of bytes returned: 2
Related Commands: RR (Retries)
Minimum Firmware Version Required: 4.22

TT (Streaming Limit) Command

<Networking and Security> Set/Read the number of bytes that can be sent out before a random delay is issued. TT Command is used to simulate full-duplex behavior.

If a module is sending a continuous stream of RF data, a delay is inserted (transmission is stopped, allowing other modules time to transmit (once it sends number of bytes specified by TT Command). Inserted random delay lasts between 1 and 'RN + 1' delay slots, where each delay slot lasts 38 ms.

AT Command: ATTT
Binary Command: 0x1A (26 decimal)
Parameter Range: 0 - 0xFFFF (bytes)
Default Parameter Value: 0xFFFF (65535d)
Number of bytes returned: 2
Related Commands: RN (Delay Slots)
Minimum Firmware Version Required: 4.22

VR (Firmware Version) Command

<Diagnostics> Read the Firmware Version of the module.

AT Command: ATVR
Binary Command: 0x14 (20 decimal)
Parameter Range: 0 - 0xFFFF (read-only)
Number of bytes returned: 2

WR (Write) Command

<(Special)> WR Command writes configurable parameters to the module's non-volatile memory (Parameter values remain in the module's memory until overwritten by future use of WR Command).

If changes are made without writing them to non-volatile memory, the module reverts back to previously saved parameters the next time the module is powered-on.

AT Command: ATWR
Binary Command: 0x08

4. RF Communication Modes

Network configurations covered in this chapter are described in terms of the following:

- Network Topology (Point-to-Point, Point-to-Multipoint or Peer-to-Peer)
- RF Communication Type (Basic or Acknowledged)
- RF Mode (Streaming, Repeater, Acknowledged or Multi-Streaming)

The following table provides a summary of the network configurations supported.

Table 4-01. Summary of network configurations supported by the XStream OEM RF Module

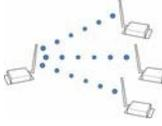
Point-to-Point		
	Definition	An RF data link between two modules.
	Sample Network Profile * (Broadcast Communications)	Use default values for all modules.
	Sample Network Profile * (Acknowledged Communications)	All Modules: ATAM (auto-set MY (Source Address) parameter) ** ATDT FFFF (set Destination Address to 0xFFFF)
	Basic Communication RF Modes	Streaming Mode (p37), Repeater Mode (p38)
	Acknowledged Communication RF Mode	Acknowledged Mode (p41)
Point-to-Multipoint		
	Definition	RF data links between one base and multiple remotes.
	Sample Network Profile * (Basic Communications)	Base: ATMY 0 (set Source Address to 0x00) ATDT FFFF (set Destination Address to 0xFFFF)
		Remotes: ATAM (auto-set MY (Source Address) parameter) ** ATDT 0 (set Destination Address to 0x00)
	Sample Network Profile * (Acknowledged Communications)	Base: ATMY 0 (set Source Address to 0x00) ATDT FFFF (set Destination Address to 0xFFFF) ATRR 3 (set number of Retries to 3)
		Remotes: ATAM (auto-set MY (Source Address) parameter) ** ATDT 0 (set Destination Address to 0x00) ATRR 3 (set number of Retries to 3)
Basic Communication RF Modes	Streaming Mode (p37), Repeater Mode (p38)	
Acknowledged Communication RF Modes	Acknowledged Mode (p41), Multi-Streaming Mode (p43)	
Peer-to-Peer		
	Definition	Modules remain synchronized without use of a master/server. Each module shares the roles of master and slave. Digi's peer-to-peer architecture features fast synch times (35ms to synchronize modules) and fast cold start times (50ms before transmission).
	Sample Network Profile * (Basic Communications)	Use default values for all modules.
	Sample Network Profile * (Acknowledged Communications)	All Modules: ATAM (auto-set MY (Source Address) parameter) ** ATDT FFFF (set Destination Address to 0xFFFF) ATRR 3 (set number of Retries to 3)
	Basic Communication RF Mode	Streaming Mode (p37)
	Acknowledged Communication RF Mode	Acknowledged Mode (p41)

* Assume default values for parameters not listed. Profiles do not reflect addressing implementations.

** AM (Auto-set MY) Command must be issued through a terminal program such as the one incorporated in the XCTU "Terminal" tab.

4.1. Addressing

Each RF packet contains addressing information that is used to filter incoming RF data. Receiving modules inspect the Hopping Channel (HP parameter), Vendor Identification Number (ID parameter) and Destination Address (DT parameter) contained in each RF packet. Data that does not pass through all three network security layers is discarded.

Figure 4-01. Filtration layers contained in the RF packet header

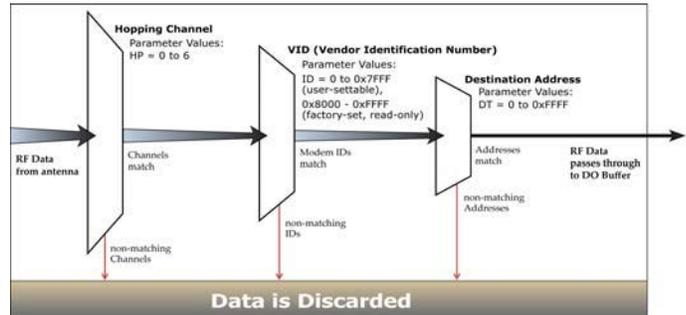

4.1.1. Address Recognition

Transmissions can be addressed to a specific module or group of modules using the DT (Destination Address) and MK (Address Mask) parameters. The transmitting module dictates whether the packet is intended for a specific module (local address) or multiple modules (global address) by comparing the packet's DT parameter to its own MK parameter.

Figure 4-02. Local Packets vs. Global Packets (Transmitting Module)

TX_DT = Transmitter Destination Address
TX_MK = Transmitter Address Mask

Note: When TX_DT = 0xFFFF (default), RF packets are global and are received by all modules within range. (Receivers do not send ACKs.)

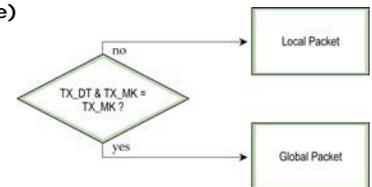

A receiving module will only accept a packet if a packet is addressed to it (either as a global or local packet). The RX module makes this determination by inspecting the destination address of the RF packet and comparing it to its own address and mask. The Destination Address of the TX module is logically "ANDed" with the Address Mask of the RX module.

Figure 4-03. Address Recognition (Receiving Module)

TX_DT = Transmitter
RX_DT = Receiver De
RX_MY = Receiver Sc

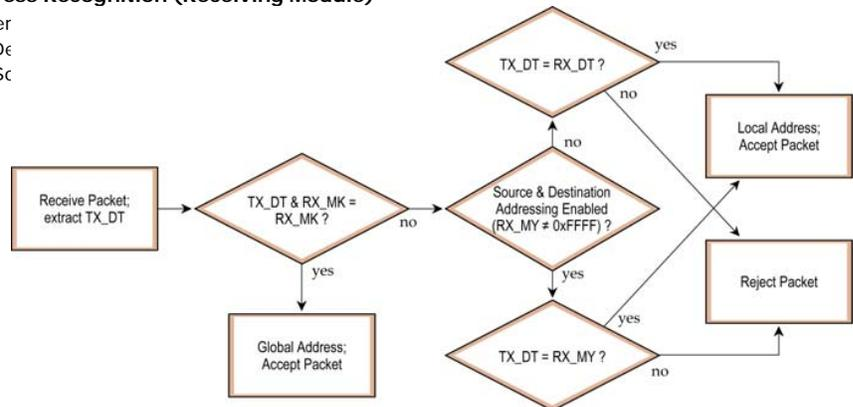

Note: For more information regarding addressing and masks, refer to Application Note "XST-AN004b" (located on the web at: www.digi.com.)

4.2. Basic Communications

Basic Communications are accomplished through two sub-types:

- Broadcast - By default, XStream Modules communicate through Broadcast communications and within a peer-to-peer network topology. When any module transmits, all other modules within range will receive the data and pass it directly to their host device.
- Addressed - If addressing parameters match, received RF data is forwarded to the DO (Data Out) buffer; otherwise, the RF data is discarded.

When using Basic Communications, any functions such as acknowledgements are handled at the application layer by the OEM/integrator. The Broadcast Modes provide transparent communications, meaning that the RF link simply replaces a wired link.

4.2.1. Streaming Mode (Default)

Characteristics: Highest data throughput
 Lowest latency and jitter
 Reduced immunity to interference

Transmissions never acknowledged (ACK) by receiving module(s)

Required Parameter Values (TX Module): RR (Retries) = 0

Related Commands: Networking (DT, MK, MY), Serial Interfacing (PK, RB, RO, TT)

Recommended Use: Mode is most appropriate for data systems more sensitive to latency and/or jitter than to occasional packet loss. For example: streaming audio or video.

Streaming Mode Data Flow

Figure 4-04. Streaming Mode State Diagram (TX Module)

Events and processes in this mode are common to all of the other RF Modes.

Note: When streaming data, RB and RO parameters are only observed on the first packet.

After transmission begins, the TX event will continue uninterrupted until the DI buffer is empty or the streaming limit (TT Command) is reached. As with the first packet, the payload of each subsequent packet includes up to the maximum packet size (PK Command).

The streaming limit (TT Command) is specified by the transmitting module as the maximum number of bytes the transmitting module can send in one transmission event. After the TT parameter threshold is reached, the transmitting module will force a random delay of 1 to RN delay slots (exactly 1 delay slot if RN = 0).

Subsequent packets are sent without an RF initializer since receiving modules stay synchronized with the transmitting module for the duration of the transmission event (from preceding packet information). However, due to interference, some receiving modules may lose data (and synchronization to the transmitting module), particularly during long transmission events.

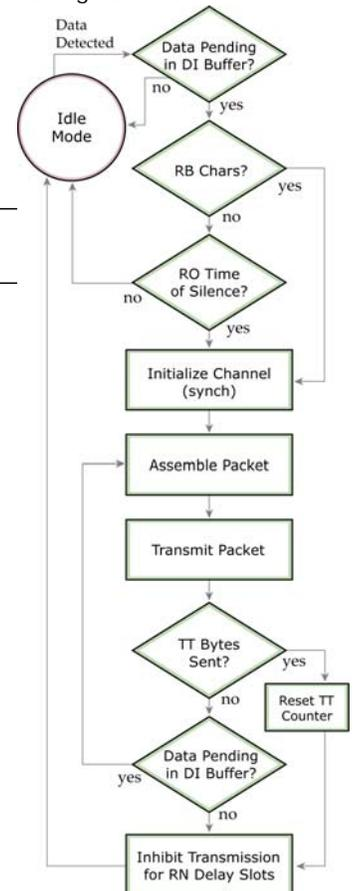

Once the transmitting module has sent all pending data or has reached the TT limit, the transmission event ends. The transmitting module will not transmit again for exactly RN delay slots if the local (i.e. transmitting module's) RN parameter is set to a non-zero value. The receiving module(s) will not transmit for a random number of delay slots between 0 and (RN-1) if the local (i.e. receiving module's) RN parameter is set to a non-zero value. These delays are intended to lessen congestion following long bursts of packets from a single transmitting module, during which several receiving modules may have become ready to transmit.

4.2.2. Repeater Mode

- Characteristics:** Self-organizing - No route configuration is necessary
Self-healing / Fault-tolerant
Low power consumption and Minimized interference
Network throughput is determined by number of hops, not by number of repeaters. Multiple repeaters within range of source node count as one hop.
Supports "transparent" multi-drop mode or addressed data filtering mode.
Duplicate RF packets are automatically filtered out.
All packets propagate to every node in the network (filtering rules apply).
Broadcast communications - each packet comes out every node exactly once.
Addressed communications - all radios see every packet. Only the module with a matching address will forward it to the DO buffer (UART IN).
Data entering the network on any module is transmitted and forwarded through every repeater module until it reaches the ends of the network.
Each repeater will repeat a packet only once.
- Constraints:** Requires that each module have a unique MY (Source Address) parameter.
System must introduce just one packet at a time to the network for transmission (256 bytes max).
Each hop (H) decreases network throughput by a factor of $1/(H+1)$.
Additional repeaters add network redundancy without decreasing throughput.
- Required Parameter Values (TX Module):** MD = 3 or 4, MY = unique value (can be accomplished by issuing the AM (Auto-set MY) and WR (Write) commands to all modules in the network)
- Related Commands:** Networking (MD, DT, MY, AM), Serial Interfacing (RN, PK, RO, RB)
- Recommended Use:** Use in networks where intermediary nodes are needed to relay data to modules that are beyond the transmission range of the base module.

Theory of Operation

OEMs and integrators can extend the effective range and reliability of a data radio system by forwarding traffic through one or more repeaters.

Instead of using routing tables and path discovery to establish dynamic paths through a network, the repeater system uses a sophisticated algorithm to propagate each RF packet through the entire network.

The network supports RF packets up to 256 bytes. The repeater network can operate using broadcast or addressed communications for multi-drop networks and works well in many systems with no special configuration.

When in Repeater Mode, the network repeats each message among all available nodes exactly one time. This mechanism eliminates the need for configuring specific routes. The network is self-organizing and self-healing so that the system is able to receive transmissions in the event of a module going down.

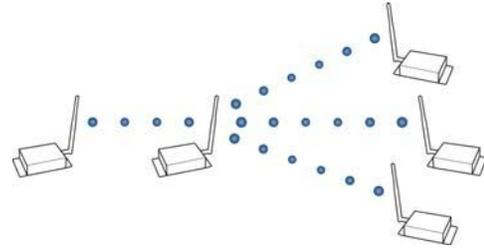
Figure 4-05. Sample Repeater Network Topology

Repeater Network Configuration

A network may consist of End Nodes (EN), End/Repeater Nodes (ERN) and a Base Node (BN). The base node initiates all communications.

The repeater network can be configured to operate using Basic Broadcast or Basic Addressed communications. The addressing capabilities of the modules allow integrators to send a packet as a global packet (DT = 0xFFFF) and shift out of every radio in the network (Basic Broadcast). Alternatively, the packet can be sent with a specific DT (Destination Address) parameter so that it is only accepted by a specific remote node (Basic Addressed).

Configuration Instruction (Basic Broadcast Communications)

Assign each module a unique MY (source) address. (The AM (Auto-set MY) command will configure a unique source address that is based on module serial number.)

Enable Basic Broadcast Communications (DT = 0xFFFF) or Addressed Broadcast Communications (ATDT specifies a specific destination)

Configure PK, RO and RB to ensure that RF packet aligns with protocol packet. (ex. PK=0x100, RB=0x100, RO depends on baud rate).

Configure one or more repeaters in the system (ATMD = 3).

Configure remote nodes as destinations (MD = 4). This will ensure that the remote node waits for the repeater traffic to subside before it transmits a response.

Assign each module a unique MY (source) address. (The AM (Auto-set MY) command will configure a unique source address that is based on module serial number.)

Enable Basic Broadcast Communications (DT = 0xFFFF) or Addressed Broadcast Communications (ATDT specifies a specific destination)

Configure PK, RO and RB to ensure that RF packet aligns with protocol packet. (ex. PK=0x100, RB=0x100, RO depends on baud rate).

Configure one or more repeaters in the system (ATMD = 3).

Configure remote nodes as destinations (MD = 4). This will ensure that the remote node waits for the repeater traffic to subside before it transmits a response.

The configuration instructions above reflect configuration for a Basic Broadcast Repeater system. To configure a Basic Addressed Repeater system, use the DT (Destination Address) parameter to assign unique addresses to each module in the network.

Algorithm details

- Packet ID (PID) is composed of transmitting module MY address and packet serial number.
- Incoming packets with a PID already found in the PID buffer will be ignored.
- Each module maintains a PID buffer 8 deep of previously received packets (managed as FIFO).

Packets may be shifted out the serial port and/or repeated depending on the DT parameter contained in the RF packet.

Table 4-02. DT (Destination Address) parameter truth table

Address Match	Send out serial port?	Repeat?
Global	Yes	Yes
Local	Yes	No
None	No	Yes

Repeat delay based on RSSI

A transmitted packet may be received by more than one repeater at the same time. In order to reduce the probability that the repeaters will transmit at the same instant, resulting in a collision and possible data loss; an algorithm has been developed that will allow a variable back-off prior to retransmission of the packet by a repeater. The algorithm allows radios that receive the packet with a stronger RF signal (RSSI) to have the first opportunity to retransmit the packet.

The RN (Delay Slots) parameter is used to configure this delay. Set RN=0 (no delays) for small networks with few repeaters or repeaters that are not within range of each other. Set RN=1 for systems with 2 to 5 repeaters that may be within range of each other.

The actual length of the delay is computed by the formula:

$$\text{Delay (ms)} = L * DS$$

$$DS = (-41 - \text{RSSI}) / 10 * RN + \text{RandomInt}(0, RN)$$

Where L is the length of the transmitted packet in milliseconds, DS is the number of delay slots to wait, RSSI is the received signal strength in dBm, RN is the value of the RN register and RandomInt(A,B) is a function that returns a random integer from A to B-0

Response packet delay

As a packet propagates through the repeater network, if any node receives the data and generates a quick response, the response needs to be delayed so as not to collide with subsequent retransmissions of the original packet. To reduce collisions, both repeater and end node radios in a repeater network will delay transmission of data shifted in the serial port to allow any repeaters within range to complete their retransmissions.

The time for this delay is computed by the formula:

$$\text{Maximum Delay (ms)} = L * DS$$

$$DS = ((-41 - (-100)) / 10) * RN + RN + 1$$

Where L is the length of the transmitted packet in milliseconds, DS is the number of delay slots to wait, RSSI is the received signal strength in dBm, and RN is the value of the RN register.

Use Case - Broadcast Repeater Network

Consider modules R1 through R10 each communicating to a PLC using the ModBus protocol and spaced evenly in a line. All ten nodes are configured as “destinations and repeaters” within the scope of Basic Broadcast Communications (MD=3, AM, DT=0xFFFF, PK=0x100, RO=0x03, RB=0x100, RN=1). The Base Host (BH) shifts payload that is destined for R10 to R1. R1 initializes RF communication and transmits payload to nodes R2 through R5 which are all within range of R1. Modules R2 through R5 receive the RF packet and retransmit the packet simultaneously. They also send the data out the serial ports, to the PLC's.

Table 4-03. Commands used to configure repeater functions

AT Command	Binary Command	AT Command Name	Range	# Bytes Returned	Factory Default
AM	0x3A (58d)	Auto-set MY	-	-	-
DT	0x00 (0d)	Destination Address	0 – 0xFFFF	2	0
MD	0x3C (60d)	RF Mode	3 - 4	1	0
MY	0x2A (42d)	Source Address	0 – 0xFFFF	2	0xFFFF
RN	0x19 (25d)	Delay Slots	0 – 0xFF (slots)	1	0
WR	0x08 (8d)	Write	-	-	-

Bandwidth Considerations

Using broadcast repeaters in a network reduces the overall network data throughput as each repeater must buffer an entire packet before retransmitting it. For example: if the destination is within range of the transmitter and the packet is 32 bytes long, the transmission will take 72ms on a 9600 baud XStream Module (much faster modules are available). If that same packet has to propagate through two repeaters, it will take 72ms to arrive at the first repeater, another 72 ms to get to the second and a final 72ms to get to the destination for a total of 216ms. Taking into account UART transfer times (~1ms/byte at 9600 baud), a server to send a 32 byte query and receive a 32 byte response is ~200ms, allowing for 5 polls per second. With the two repeaters in the path, the same query/response sequence would take about 500ms for 2 polls per second.

To summarize, this system is sending and receiving 64 bytes 5 times per second for a throughput of 320 bytes per second with no repeaters and 128 bytes per second with 2 repeaters. Generally, the network throughput will decrease by a factor of 1/(R+1), with R representing the number of repeaters between the source and destination.

Note that these numbers are absolutely worst case to illustrate how the system would perform in a typical, low bandwidth system. As a counter example the 115kbps 9XTend radio can transfer the same 32 byte packet in 12 ms for a round trip with UART transfer times of ~30ms or 33 polls per second (1066 bytes per second) with no repeaters. With two repeaters the time would be ~100ms round trip time for 10 polls per second or 320 bytes per second network throughput with two repeaters.

If the transmitting module does not receive the ACK within the allotted time, it will retransmit the packet with a new RF initializer following the ACK slot. There is no delay between the first ACK slot and the first retransmission. Subsequent retransmissions incur a delay of a random number of delay slots, between 0 and RN. If RN is set to 0 on the transmitting module, there are never any back-off delays between retransmissions. Note that during back-off delays, the transmitting module will go into Idle Mode and may receive RF data. This can have the effect of increasing the back-off delay, as the radio cannot return to RF transmit (or retransmit) mode as long as it is receiving RF data.

After receiving and acknowledging a packet, the receiving module will move to the next frequency and listen for either a retransmission or new data for a specific period of time. Even if the transmitting module has indicated that it has no more pending transmit data, it may have not received the previous ACK, and so it may retransmit the packet (potentially with no delay after the ACK slot). In this case, the receiving module will always detect the immediate retransmission, which will hold off the communications channel and thereby reduce collisions. Receiving modules acknowledge each retransmission they receive, but they only pass the first copy of a packet they receive out the UART.

RB and RO parameters are not applied to subsequent packets. This means that once transmission has begun, it will continue uninterrupted until the DI buffer is empty or the streaming limit (TT) has been reached. As with the first packet, the payload of each subsequent packet includes up to the maximum packet size (PK parameter). The transmitting module checks for more pending data near the end of each packet.

The streaming limit (TT parameter) specifies the maximum number of bytes that the transmitting module will send in one transmission event, which may consist of many packets and retries. If the TT parameter is reached, the transmitting module will force a random delay of 1 to RN delay slots (exactly 1 delay slot if RN is zero). Each packet is counted only once toward TT, no matter how many times the packet is retransmitted.

Subsequent packets in acknowledged mode are similar to those in streaming mode, with the addition of an acknowledgement between each packet, and the possibility of retransmissions. Subsequent packets are sent without an RF initializer, as the receiving modules are already synchronized to the transmitting module from the preceding packet(s) and they remain synchronized for the duration of the transmission event. Each retransmission of a packet includes an RF initializer.

Once the transmitting module has sent all pending data or has reached the TT limit, the acknowledged transmission event is completed. The transmitting module will not transmit again for exactly RN delay slots, if the local RN parameter is set to a nonzero value. The receiving module will not transmit for a random number of delay slots between 0 and (RN-1), if the local RN parameter is set to a nonzero value. These delays are intended to lessen congestion following long bursts of packets from a single transmitting module, during which several receiving modules may have themselves become ready to transmit.

4.3.2. Multi-Streaming Mode

Characteristics: Enables exclusive connections (refer to “Operation” section for definition) Supports the passing of large data streams (> 256 bytes) from multiple remote modules to a base module (If a complete data stream from a remote module is less than 256 bytes, data can be sent from several remotes to a base location without enabling this mode and latencies will be much less.)

Transmissions never acknowledged (ACK) by receiving module(s)

Required Parameter Values (TX Module): MD = 1 (Base), MD = 2 (Remote), RN > 0, RR > 0, MY ≠ 0xFFFF

Recommended Use: Use this mode in point-to-multipoint networks where remote modules initiate communications and require exclusive (uninterrupted) connections to the base module.

Table 4-05. Sample Network Profile

Module	Parameter Settings (assume default values for parameters not listed)
Base	ATMD 1 (configure module as Multi-Stream Base) *
Remotes	ATMD 2 (configure module as Multi-Stream Remote) *

* When Multi-Streaming is enabled, the following parameters are consequently modified (if they have not already been modified from their default states): RR, RN, MY, CD, AT and BT. (refer to Table 4-06)

Theory of Operation

When in Multi-Streaming Mode, all remote modules can initiate communications with the base module at the same time, but only one remote is granted an exclusive connection. After an exclusive connection begins, data is transferred exclusively between two modules without interruption from any other modules in the network.

An exclusive connection is a bi-directional connection that can only be established when in Multi- Streaming Mode. An exclusive connection is immune to other remote modules interrupting the connection and interleaving data (The interleaved data potentially renders the base module unable to discern from which remote module the data was transmitted).

When an exclusive connection is granted to a single remote, the other remotes are notified that the connection exists. The notification causes the remote modules to postpone transmissions until the base module sends notification that the exclusive connection has ended.

Figure 4-07. Sample Connection Sequence Diagram

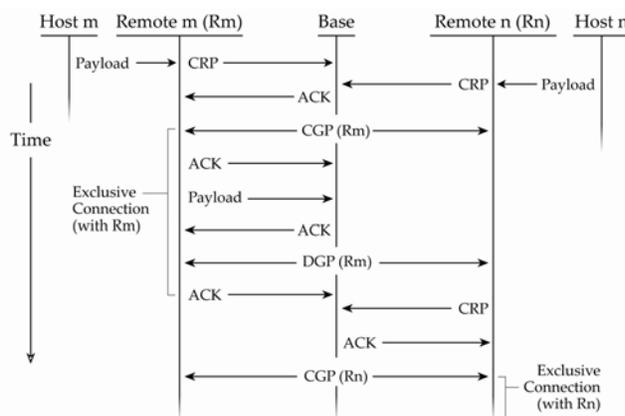

CRP = Connection Request Packet
CGP = Connection Grant Packet
DRP = Disconnect Request Packet (not shown in diagram – applicable when remote connection is disconnected using the pin sleep I/O line).
DGP = Disconnect Grant Packet
ACK = Acknowledgement of reception.
Base module = The central transmitting/receiving module in a network of modules that maintains communications with remote modules.
Remote module = A module in a network that sends data to and receives data from a base module.
Payload = Data contained inside the RF Data of the RF Packet that originates from a host to be transmitted over-the-air.

In the connection sequence above, an exclusive connection is first granted to “Remote m”. The CGP (Connection Grant Packet) is broadcast to all remote modules in the network to communicate the base is engaged in an exclusive connection. Upon receipt of the CGP notification, remote modules will wait for a DGP (Disconnect Grant Packet) before attempting again to send data to the base module.

Initiating a Connection

Connection Guidelines:

- A remote module can only request a connection with the base module.
- The base module may hold off or grant a connection request to another module.
- A remote module will not try to establish a connection if one already exists.
- A connection fails if no response is received after RR (Retries) CRP packets. After a failure, whatever condition was causing a connection to be established is cleared. If the condition was data to be sent, all data in the DI buffer will be flushed. If the condition was DI3 transition, then no connection will be attempted until another correct DI3 transition.
- A global connection cannot fail. (Definition is on next page.)

Once in Multi-Streaming Mode ($MD > 0$), several events can initiate an exclusive connection:

1. Remote module has payload to transmit. After a remote module receives data from its host, the module will attempt to establish a connection with the base module. The connection is defined by the remote’s DT (Destination Address) parameter. If another remote has a connection with the base, no connection will be established until the connection runs its course. Any remotes requesting a connection will then arbitrate for the next connection. RR (Retries) and RN (Random back-off) parameters control this arbitration.
2. Base sets the DT (Destination Address) parameter. When the base module sets the DT (Destination Address) parameter, an exclusive connection is immediately initiated with the remote module that has a matching DT parameter. After the DT command is sent (If $ATCM=1$), the base module indicates a successful connection with a “CONNECT XXXX” string where “XXXX” is the remote’s address. An unsuccessful connection is indicated with an “ERROR” string. If the connection is successful, the module immediately exits AT Command Mode and data can be sent to and received from the connected remote module. If an error is returned, the module stays in AT Command Mode. If a base is connected to a remote when the DT command is executed, the current connection is disconnected before a new connection is created.
3. DI3 pin (pin 2, SLEEP) is asserted (set low). Both base and remote modules can create a connection (defined by the current DT (Destination Address) parameter) when the DI3 pin is asserted (driven high). DR (DI3 Configuration) Command is used to establish this mode. If a remote asserts DI3, a connection request will be sent when no connection is active. If the base asserts DI3, a connection will immediately be established with the remote after any connection.

Initiating a Disconnection

To disconnect, the base module sends a DGP (disconnect grant packet). A remote module can only request a disconnect. The following conditions cause a disconnect:

1. No over-the-air data sent or received for CE (Connection Inactivity Timeout) time. If no over-the-air data is successfully sent (no acknowledgement received) or received (any good packet) for CE time, the connection will be dropped. Only a base module can detect this condition. Refer to CE Command.
2. Absolute CB (Connection Duration Timeout). The CB parameter defines an absolute timeout. A timer is started on the remote units when a connection is established. When the connection has been active for CB time, the base will close the connection. A remote that detects this condition will automatically disconnect (it will not send a DRP (disconnect request packet)). Remotes that monitor a connection between the base and another remote will disregard any connection after the CB time. Refer to CB Command.
3. DI3 pin (pin 2, SLEEP) is de-asserted (set high). A base or remote module can cause a disconnect by setting the DI3 line high. If no connection is active, the de-assertion is ignored. A remote will request a disconnect if DI3 is de-asserted and the remote is currently connected to the base. Refer to DR (DI3 Configuration) Command.
4. A remote or a base module receives the ATDC (Disconnect) Command.

Configuration

AT Command Mode

AT command mode is used for all commands on base and remote modules. Binary command mode is not available when MD = 1 or 2.

The base is in AT command mode when not engaged in an exclusive connection with a remote. No AT Command Mode sequence is needed. When a base module is connected to a remote module, the AT Command Mode sequence is used to enter AT command mode. The connection with the remote is maintained. Care should be taken that the CE (Connection Inactivity) timeout does not occur while in AT Command Mode.

The remote must use the AT command sequence to enter AT Command Mode. When a connection exists with a base module, the connection is maintained. Care must be taken that the CB (Connection Duration) timeout does not occur while in AT Command Mode.

As of firmware version, 4.30, a faster method is available for entering AT Command Mode. If the BT and AT parameters are set to 0, BT (Guard Time Before) and AT (Guard Time After) times are set to 6 milliseconds.

Beware that this will also mean that AT Command Mode cannot be entered by manually typing the AT command sequence (usually "+++"), because the AT time will occur faster than the characters can be typed.

Auto Configuration

When enabling Multi-Streaming Modes (by setting the MD (RF Mode) parameter to 1 or 2), other parameter values are automatically modified to support the mode. For example, when the MD parameter is changed to 1 or 2, the RR parameter is changed to 0x0A (hex). The modification only occurs if the RR parameter is 0 (its default) before the MD command was executed. If any other value is found for the RR parameter, the RR parameter will not be changed. Auto configuration occurs every time the module is powered-up.

Table 4-06. Auto Configurations

Parameter changed when MD = 1 or 2	Condition for modification to take place (default values)	Resulting Parameter Value
RR (Retries)	If RR = 0	RR = 0x0A (10 decimal)
RN (Delay Slots)	If RN = 0	RN = 5
MY (Source Address)	If MY = 0xFFFF (and MD = 2)	Unique value based on serial number *
CD (DO3 Configuration)	If CD = 0	CD = 3
BT (Guard Time Before)	If BT = 0x0A	BT = 0
AT (Guard Time After)	If AT = 0x0A	AT = 0

* The system requires that each remote have a unique address. The automatic address is based on the serial number and is not guaranteed unique, although the chances for a duplicate address are 1 in 16,000. No method currently exists for detecting and reassigning duplicate remote addresses.

Global Connection

The base module can connect to all remote modules (to send a broadcast message) by connecting with a DT address of 0xFFFF (hex). There will be no acknowledgements from the remote radios and each packet from the base will be sent RR times. A remote cannot send messages to a base during a global connect.

The CGP and DGP packets will be sent RR times to begin and end the global connection respectively. The connection can be terminated by CE, CB timers, DI3 or ATDC Command as any other connections.

Sleep Modes and Connections

Cyclic sleep can be used with the remote modules to conserve power. ST "Time before Sleep" Parameter defines how long after a disconnect a remote will stay awake. A module is not allowed to enter sleep mode when it is engaged in a connection. A module will wake as defined by SM parameter and check for an RF message. If a message is detected, the module will stay awake only if the message is a connect message from the base for this module. DI3 (pin 2) wake-up can be used to wake a remote module. Usually the connection on DI3 should also be enabled so that a connection is established on wake-up.

Note: The ST (Time Before Sleep) time must be set long enough to account for the time it could take to make a connection if several remote modules get a connection before a remote's ST times out.

Pin sleep can also be used with a remote module. A module will not be allowed into pin sleep while a connection is active. Usually the connection on DI3 (DR = 4) should also be enabled so that a connection is established on wakeup. Pin wake-up could also be used to scan for a connection at an interval not defined by the cyclic sleep modes.

I/O Passing and Connections

I/O lines can be passed between a remote and base module by enabling I/O line passing (see the RT, DR, CD, CO, CS, BK, BO commands). When a connection is not active, the output lines on the base and remote modules will be in their default state. When a connection is established, the base and remote output line will be set to reflect the corresponding input lines.

Monitoring Connections

The DO3 pin (RX LED) can be used to show when a connection is active on both remote and base modules. This is the default condition. This line will be asserted (high) during a connection and de-asserted (low) when there is no connection.

A base module can also be set to send the "CONNECT XXXX" string (where "XXXX" is the connecting module's MY (Source Address) parameter) anytime a connection is established. Refer to CM (Connection Message) Command.

Appendix A: Agency Certifications

FCC Certification

The XStream OEM RF Module complies with Part 15 of the FCC rules and regulations. Compliance with the labeling requirements, FCC notices and antenna usage guidelines is required.

To fulfill the FCC Certification requirements, the OEM must comply with the following FCC regulations:

1. The system integrator must ensure that the text on the external label provided with this device is placed on the outside of the final product (Figure A.1 for 900 MHz operations or Figure A.2 for 2.4 GHz operations).
2. The XStream OEM RF Module may be used only with Approved Antennas that have been tested with this module. (Table A-01 or Table A-02)

FCC Notices:

IMPORTANT: The 9XStream (900 MHz) and 24XStream (2.4 GHz) OEM Modules have been certified by the FCC for use with other products without any further certification (as per FCC section 2.1091). Changes or modifications not expressly approved by Digi could void the user's authority to operate the equipment.

IMPORTANT: OEMs must test their final product to comply with unintentional radiators (FCC section 15.107 and 15.109) before declaring compliance of their final product to Part 15 of the FCC Rules.

IMPORTANT: The XStream OEM RF Modules have been certified for remote and base radio applications. If the XStream will be used for portable applications, the device must undergo SAR testing.

This equipment has been tested and found to comply with the limits for a Class B digital device, pursuant to Part 15 of the FCC Rules. These limits are designed to provide reasonable protection against harmful interference in a residential installation. This equipment generates, uses and can radiate radio frequency energy and, if not installed and used in accordance with the instructions, may cause harmful interference to radio communications. However, there is no guarantee that interference will not occur in a particular installation. If this equipment does cause harmful interference to radio or television reception, which can be determined by turning the equipment off and on, the user is encouraged to try to correct the interference by one or more of the following measures:

- Re-orient or relocate the receiving antenna.
- Increase the separation between the equipment and receiver.
- Connect the equipment into an outlet on a circuit different from that to which the receiver is connected.
- Consult the dealer or an experienced radio/TV technician for help.

OEM Labeling Requirements

Label Warning

 **WARNING:** The Original Equipment Manufacturer (OEM) must ensure that FCC labeling requirements are met. This includes a clearly visible label on the outside of the final product enclosure that displays the contents shown in the figure below.

Figure A-01. Required FCC Label for OEM products containing 9XStream (900 MHz) OEM RF Module

Contains FCC ID: OUR9XSTREAM

The enclosed device complies with Part 15 of the FCC Rules. Operation is subject to the following two conditions: (1) this device may not cause harmful interference and (2) this device must accept any interference received, including interference that may cause undesired operation.

Figure A-02. Required FCC Label for OEM products containing 24XStream (2.4 GHz) OEM RF Module

Contains FCC ID: OUR-24XSTREAM

The enclosed device complies with Part 15 of the FCC Rules. Operation is subject to the following two conditions: (1) this device may not cause harmful interference and (2) this device must accept any interference received, including interference that may cause undesired operation.

Antenna Usage

Antenna Warning

 **WARNING:** This device has been tested with Reverse Polarity SMA connectors with the antennas listed in Tables A.1 and A.2 of Appendix A. When integrated in OEM products, fixed antennas require installation preventing end-users from replacing them with non-approved antennas. Antennas not listed in the tables must be tested to comply with FCC Section 15.203 (unique antenna connectors) and Section 15.247 (emissions).

RF Exposure

 **WARNING:** This equipment is approved only for mobile and base station transmitting devices, separation distances of (i) 20 centimeters or more for antennas with gains < 6 dBi or (ii) 2 meters or more for antennas with gains \geq 6 dBi should be maintained between the antenna of this device and nearby persons during operation. To ensure compliance, operation at distances closer than this is not recommended.

The preceding statement must be included as a CAUTION statement in manuals for OEM products to alert users on FCC RF Exposure compliance.

Digi Modules are pre-FCC approved for use in fixed base station and mobile applications. As long as the antenna is mounted at least 20 cm (8 in) from nearby persons, the application is considered a mobile application. If the antenna will be mounted closer than 20 cm to nearby persons, then the application is considered “portable” and requires an additional test performed on the final product. This test is called the Specific Absorption Rate (SAR) testing and measures the emissions from the module and how they affect the person.

Over 100 additional antennas have been tested and are approved for use with Digi 900 MHz Modules (including “Mag Mount”, “Dome”, “Multi-path” and “Panel” antennas). Because of the large number of approved antennas, Digi requests that you send specific information about an antenna you would like to use with the module and Digi will evaluate whether the antenna is covered under the FCC certification.

FCC-Approved Antennas

Table A-01. Antennas approved for use with 9XStream (900 MHz) OEM RF Modules.

Manufacturer	Part Number	Type	Gain	Application	Min. Separation Distance
*	*	Yagi	6.2 dBi	Fixed/Mobile **	20 cm
*	*	Yagi	7.2 dBi	Fixed/Mobile **	20 cm
Digi	A09-Y8	Yagi	8.2 dBi	Fixed/Mobile **	20 cm
*	*	Yagi	9.2 dBi	Fixed/Mobile **	20 cm
*	*	Yagi	10.2 dBi	Fixed/Mobile **	20 cm
Digi	A09-Y11 (FCC pending)	Yagi	11.2 dBi	Fixed/Mobile **	20 cm
Digi	A09-F2	Omni Direct.	2.2 dBi	Fixed **	20 cm
Digi	A09-F5	Omni Direct.	5.2 dBi	Fixed **	20 cm
Digi	A09-F8	Omni Direct.	8.2 dBi	Fixed **	20 cm
*	*	Omni Direct.	9.2 dBi	Fixed **	20 cm
*	*	Omni Direct.	7.2 dBi	Fixed **	20 cm
Digi	A09-M7	Omni Direct.	7.2 dBi	Fixed **	20 cm
Digi	A09-H	1/2 wave antenna	2.1 dBi	Fixed/Mobile **	20 cm
Digi	A09-HBMM-P5I	1/2 wave antenna	2.1 dBi	Fixed/Mobile **	1 cm
Digi	A09-QBMM-P5I	1/4 wave antenna	1.9 dBi	Fixed/Mobile **	1 cm
*	*	1/4 wave integrated wire antenna	1.9 dBi	Fixed/Mobile **	1 cm

Table A-02. Antennas approved for use with 24XStream (2.4 GHz) OEM RF Modules.

Manufacturer	Part Number	Type	Gain	Application	Min. Separation Distance
*	*	Yagi	6 dBi	Fixed **	2 m
*	*	Yagi	8.8 dBi	Fixed **	2 m
*	*	Yagi	9 dBi	Fixed **	2 m
*	*	Yagi	10 dBi	Fixed **	2 m
*	*	Yagi	11 dBi	Fixed **	2 m
*	*	Yagi	12 dBi	Fixed **	2 m
*	*	Yagi	12.5 dBi	Fixed **	2 m
*	*	Yagi	13.5 dBi	Fixed **	2 m
*	*	Yagi	15 dBi	Fixed **	2 m
*	*	Omni Direct	2.1 dBi	Fixed/Mobile **	20 cm
*	*	Omni Direct	3 dBi	Fixed/Mobile **	20 cm
*	*	Omni Direct	5 dBi	Fixed/Mobile **	20 cm
*	*	Omni Direct	7.2 dBi	Fixed **	2 m
*	*	Omni Direct	8 dBi	Fixed **	2 m
*	*	Omni Direct	9.5 dBi	Fixed **	2 m
*	*	Omni Direct	10 dBi	Fixed **	2 m
*	*	Omni Direct	12 dBi	Fixed **	2 m
*	*	Omni Direct	15 dBi	Fixed **	2 m
Digi	A24-P8	Panel	8.5 dBi	Fixed **	2 m
Digi	A24-P13	Panel	13 dBi	Fixed **	2 m
*	*	Panel	14 dBi	Fixed **	2 m
*	*	Panel	15 dBi	Fixed **	2 m
*	*	Panel	16 dBi	Fixed **	2 m
Digi	A24-P19	Panel	19 dBi	Fixed **	2 m
Digi	A24-HABMM-P6I	Dipole	2.1 dBi	Fixed/Mobile **	20 cm
Digi	A24-HBMM-P6I	Dipole	2.1 dBi	Fixed/Mobile **	20 cm
Digi	A24-HABSM	Dipole	2.1 dBi	Fixed/Mobile **	20 cm
Digi	A24-QABMM-P6I	Monopole	1.9 dBi	Fixed/Mobile **	20 cm
*	A24-Q1	Monopole	1.9 dBi	Fixed/Mobile **	20 cm
*	*	Monopole	1.9 dBi	Fixed/Mobile **	20cm

* FCC-approved antennas not inventoried by Digi – Contact Digi (866) 765-9885 for information.

** Can be approved for portable applications if integrator gains approval through SAR testing

IC (Industry Canada) Certification

Labeling requirements for Industry Canada are similar to those of the FCC. A clearly visible label on the outside of the final product enclosure must display the following text:

Contains Model 9XStream Radio (900 MHz), IC: 4214A-9XSTREAM

Contains Model 24XStream Radio (2.4 GHz), IC: 4214A 12008

Integrator is responsible for its product to comply with IC ICES-003 and FCC Part 15, SuB-0 B - Unintentional Radiators. ICES-003 is the same as FCC Part 15 SuB-0 B and Industry Canada accepts FCC test report or CISPR 22 test report for compliance with ICES-003.

Appendix B: Development Guide

XStream OEM Development Kit Contents

The Development Kit includes all the hardware and software needed for a robust wireless link:

Table B-01. XStream Development Kit Contents

Item	Qty.	Description	Part Number
Quick Start Guide	1	Familiarizes users with some of the module's most important functions.	MD0016
CD	1	Contains documentation, software and tools needed for RF operation.	MD0030
XStream OEM RF Module	1	Long Range OEM RF Module w/ RPSMA Connector	varies
XStream OEM RF Module	1	Long Range OEM RF Module w/ attached wire antenna	varies
Digi Interface Board	2	Enables communication to RS-232/485/422 devices	XIB-R
Antenna	1	900 MHz RPSMA, 6" Half-Wave, dipole, articulating	A09-HASM-675
Serial Loopback Adapter	1	Connects to the female RS-232 (DB-9) serial connector of the Digi Interface Board and can be used to configure the module to function as a repeater (for range testing)	JD2D3-CDL-A
NULL Modem Adapter (male-to-male)	1	Connects to the female RS-232 (DB-9) serial connector of the Digi Interface Board and can be used to connect the module to another DCE (female DB9) device	JD2D2-CDN-A
NULL Modem Adapter (female-to-female)	1	Used to bypass radios to verify serial cabling is functioning properly	JD3D3-CDN-A
Male DB-9 to RJ-45 Adapter	1	Facilitates adapting the DB-9 Connector of the Digi Interface Board to a CAT5 cable (male DB9 to female RJ45)	JE1D2-CDA-A
Female DB-9 to RJ-45 Adapter	1	Facilitates adapting the DB-9 Connector of the Digi Interface Board to a CAT5 cable (female DB9 to female RJ45)	JE1D3-CDA-A
Power Adapter	2	Allows Interface Board to be powered by a 110 Volt AC power supply	JP4P2-9V10-6F
RS-232 Cable (6')	2	Connects interface board to devices having an RS-232 serial port	JD2D3-CDS-6F

Interfacing Hardware

Digi developed proprietary interface boards to facilitate the connection between XStream OEM RF Modules and serial devices. Digi has developed an interface board that supports the RS-232/485/422 protocols (Digi part number: XIB-R).

The following section illustrates properties of the Digi XIB-R Interface Board. The Digi Interface board provides means for connecting the XStream Module to any node that has an available RS-232 or RS-485/422 connection. Since the module requires signals to enter at CMOS voltages, one of the main functions of the interface board is to convert signals between CMOS and RS-232 levels.

Digi RS-232/485 Interface Board

Figure B-01. Front View

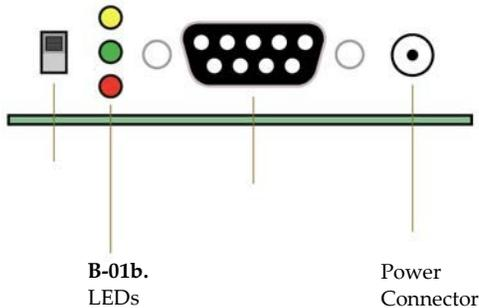

B-01a. Power Switch

Move the Power Switch to the on (up) position to power the Interface Board. DIP Switch (B.2a) settings are only read during a power-up sequence.

B-01b. LEDs

The LED indicators visualize diagnostic status information. The module's status is represented as follows:

Yellow (top LED) = Serial Data Out (to host)

Green (middle) = Serial Data In (from host)

Red (bottom) = Power/TX Indicator (Red light is on when powered, off briefly during RF transmission)



B-01c. Serial Port

Standard female DB-9 (RS-232) DCE connector – This connector can be also used for RS-485 and RS-422 connections.

B-01d. Power Connector

7-18 VDC Power Connector (Center positive, 5.5/2.1mm) – Power can also be supplied through Pin 9 of the DB-9 Serial Port.

Figure B-02. Back View

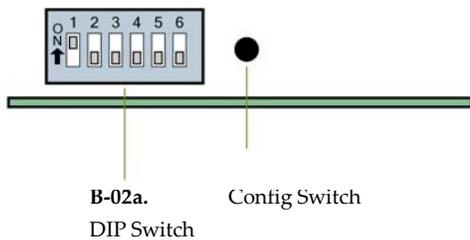

B-02a. DIP Switch

The DIP Switch automatically configures the XStream OEM RF Module to operate in different modes. Each time the module assembly (interface board + the RF Module) is powered-on, intelligence on the XIB-R interface board programs the module according to the positions of the DIP Switch. (See figure below for DIP Switch settings)

Note: In cases where AT Commands should not be sent each time the module assembly is powered-on, the processor must be disabled by populating J7 on the interface board.

B-02b. Config (Configuration) Switch

The Configuration Switch provides an alternate way to enter "AT Command Mode". To enter "AT Command Mode" at the module's default baud rate, hold the Configuration Switch down while powering on the module using the Power Switch (B-01a).

Figure B-03. Digi XIB-R (RS-232/485) Interface Board DIP Switch Settings

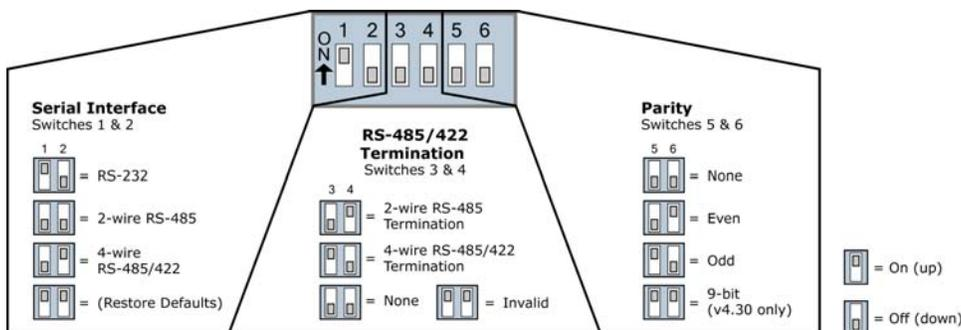

Refer to table in the Automatic DIP Switch Configurations section (next page) for more information regarding configurations triggered by the DIP Switch.

Automatic DIP Switch Configurations

Each time the module assembly (XStream Module mounted to an XIB-R Interface Board) is powered on, intelligence on the Digi Interface Board sends AT Commands that program the module based on positions of the DIP Switch. Automatic configurations that take place during the power-on sequence affect module parameter values as shown below.

To avoid overwriting previously stored custom configurations (due to the automatic configurations that take place each time the module assembly is powered on), it is necessary to disable a processor located on the XIB-R interface board. To disable the processor, populate J7 of the XIB-R Interface Board. By default, J7 jumper is not populated.

Table B-02. Module Power-up Options (J7 jumper and Config Switch)

Condition	Behavior
If J7 is populated	Processor is disabled and AT Commands are not sent to the Module.
If Config Switch is pressed	Processor is disabled and Module enters into AT Command Mode.
If J7 is NOT populated and Config Switch is NOT pressed	Execute logic as shown in table below.

Table B-03. AT Commands Sent as result of DIP Switch Settings (SW = DIP Switch)

Condition	Behavior
Restore Default Parameter Values of the Module	
If SW1 and SW2 are ON (up)	AT Commands sent: ATRE (Restore Defaults) Command ATWR (Write) Command
Serial Interfacing Options	
If SW1 is ON (up)	AT Commands sent: ATCS 0 (RS-232 Operation: CTS function for CTS line, DB-9 pin 8) ATCD 2 (DO3 - RX LED = low)
If SW1 is OFF (down)	AT Commands sent: ATCS 3 (RS-485 or RS-422 Operation) ATCD 2 (DO3 - RX LED = low)
Parity Options	
If SW5 and SW6 are OFF (down)	AT Commands sent: ATNB 0 (parity = none)
If SW5 is OFF (down) and SW6 is ON (up)	AT Commands sent: ATNB 1 (parity = even)
If SW5 is ON (up) and SW6 is OFF (down)	AT Commands sent: ATNB 2 (parity = odd)
If SW5 is ON (up) and SW6 is ON (up)	AT Commands sent: ATNB 5 (parity = 9th bit data over-the-air)
Exit AT Command Mode	
Always	AT Commands sent: ATCN (Exit AT Command Mode)

Adapters

The XStream Development Kit comes with several adapters that support the following functions:

- Performing Range Tests
- Testing Cables
- Connecting to other RS-232 DCE and DTE devices
- Connecting to terminal blocks or RJ-45 (for RS-485/422 devices)

NULL Modem Adapter (male-to-male)

Part Number: JD2D2-CDN-A (Black, DB-9 M-M) The male-to-male NULL modem adapter is used to connect two DCE devices. A DCE device connects with a straight-through cable to the male serial port of a computer (DTE).

Figure B-04. Male NULL modem adapter and pinouts

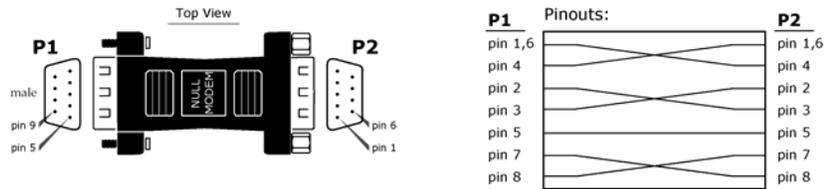
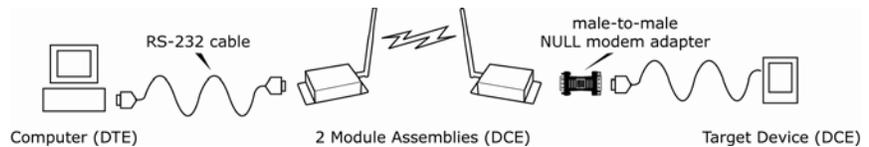

Figure B-05. Example of a module assembly (DCE Device) connecting to another DCE device)



NULL Modem Adapter (female-to-female)

Part Number: JD3D3-CDN-A (Gray, DB-9 F-F) The female-to-female NULL modem adapter is used to verify serial cabling is functioning properly. To test cables, insert the female-to-female NULL modem adapter in place of a pair of module assemblies (XIB-R-R interface board + XStream Module) and test the connection without radio modules in the connection.

Figure B-06. Female NULL modem adapter and pinouts

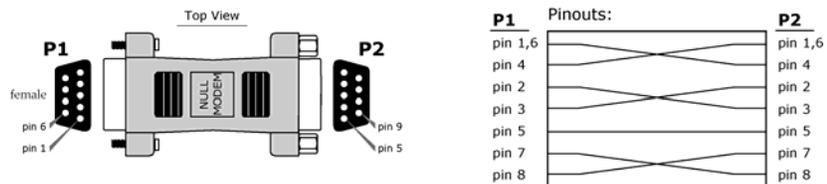

Serial Loopback Adapter

Part Number: JD2D3-CDL-A (Red, DB-9 M-F) The serial loopback adapter is used for range testing. During a range test, the serial loopback adapter configures the module assembly to function as a repeater by looping serial data back into the radio for retransmission.

Figure B-07. Serial loopback adapter and pinouts

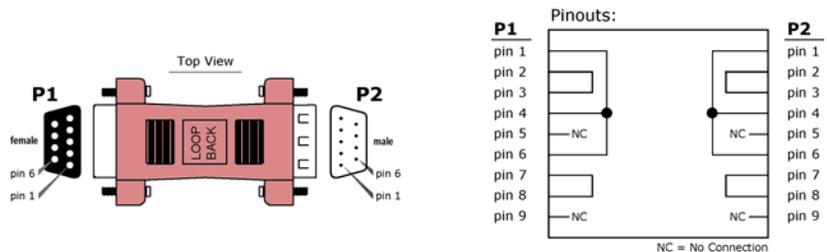

For use in RS-485/422 systems: DB-9 to RJ-45 adapters are documented on p45.

Antennas

(Refer to Appendix A for a list of FCC-Approved Antennas)

Factors that determine wireless link range:

- Ambient RF noise (interference)
- Line-of-sight obstructions
- Transmit power
- Receive sensitivity
- Antenna configuration

XStream Antenna Connector Options

To comply with the FCC rules and obtain a “modular” certification, it is required that XStream Modules utilize a “non standard” connector. This is to ensure the modules are used only with approved antennas. The XStream Modules have two connector options:

- RPSMA
- MMCX

Alternatively, the XStream Module can be order with an attached wire antenna.

RPSMA

The Reverse Polarity SMA (RPSMA) connector uses the same body as a regular SMA connector. In order to be a “non standard” connector, the gender of the center conductor is changed. The female RPSMA actually has a male center conductor.



MMCX

The Micro-Miniature Connector (MMCX) is a good solution for high volume, price-sensitive applications. The small size and snap on connection make it suitable for attaching an external mounted antenna to a module inside an enclosure.



Antenna Cables

RF cables are typically used to connect a radio installed in a cabinet to an antenna mounted externally. As a general rule, it is best to keep the RF cable as short as possible. All cables promote signal loss which is usually measured in dB loss per 100 ft. Digi provides LMR-195 rated cables. Common cables and dB losses are included in this table:

Table B-04. Potential Signal Strength Loss due to Antenna Cable Length

Cable Type	Loss at 900 MHz per 100' (loss per 100m)	Loss at 2.4 GHz per 100' (loss per 100m)	Diameter
RG-58	14.5 dB (47.4 dB)	25.3 dB (83.2 dB)	0.20" (4.95 mm)
RG-174	25.9 dB (85.0 dB)	44.4 dB (145.8 dB)	0.10" (2.54 mm)
RG-316	24.7 dB (81.0 dB)	42.4 dB (139.0 dB)	0.10" (2.59 mm)
LMR-195	11.1 dB (36.5 dB)	19.0 dB (62.4 dB)	0.20" (4.95 mm)
LMR-240	7.6 dB (24.8 dB)	12.9 dB (42.4 dB)	0.24" (6.10 mm)
LMR-600	2.5 dB (8.2 dB)	4.4 dB (14.5 dB)	0.59" (15.0 mm)

Interfacing Protocols

The Module Assembly supports the following interfacing protocols:

- RS-232
- RS-485 (2-wire) Half-Duplex
- RS-485 (4-wire) and RS-422

RS-232 Operation

DIP Switch Settings and Serial Port Connections

Figure B-08.
RS-232 DIP Switch Settings

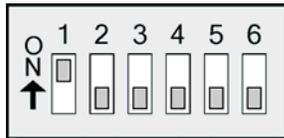

DIP Switch settings are read and applied only while powering-on.

Figure B-09
Pins used on the female RS-232 (DB-9) Serial Connector

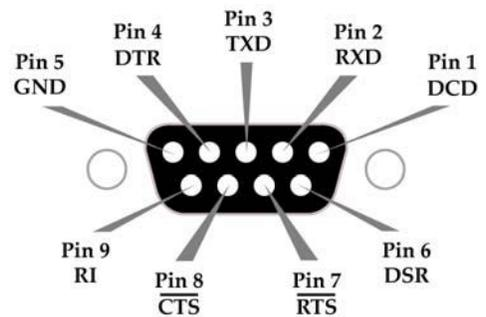

Table B-05. RS-232 Signals and their implementations on the XStream Module Assembly
(Low-asserted signals are distinguished by horizontal line over pin name.)

DB-9 Pin	RS-232 Name	AT Command Reference*	Description	Implementation
1	DCD	DO3	Data-Carrier-Detect	Connected to DSR (pin6)
2	RXD	DO	Received Data	Serial data exiting the Module Assembly (to host)
3	TXD	DI	Transmitted Data	Serial data entering into the Module Assembly (from host)
4	DTR	DI3	Data-Terminal-Ready	Can enable POWER-DOWN on the Module Assembly
5	GND	-	Ground Signal	Ground
6	DSR	DO3	Data-Set-Ready	Connected to DCD (pin1)
7	$\overline{\text{RTS}}/\text{CMD}$	DI2	Request-to-Send	Provides $\overline{\text{RTS}}$ flow control or enables "Command Mode" on the Module
8	$\overline{\text{CTS}}$	DO2	Clear-to-Send	Provides $\overline{\text{CTS}}$ flow control
9	DI	-	Ring Indicator	Optional power input that is connected internally to the positive lead of the front power connector

* The AT Command Reference provides as associative tag when using the AT commands to program the Module. "DI" stands for Data Input and "DO" for Data Output.

Wiring Diagram: RS-232 DTE Device to a DCE Module Assembly

Figure B-10. RS-232 DTE (male connector) device wired to an XStream Module Assembly (female connector)

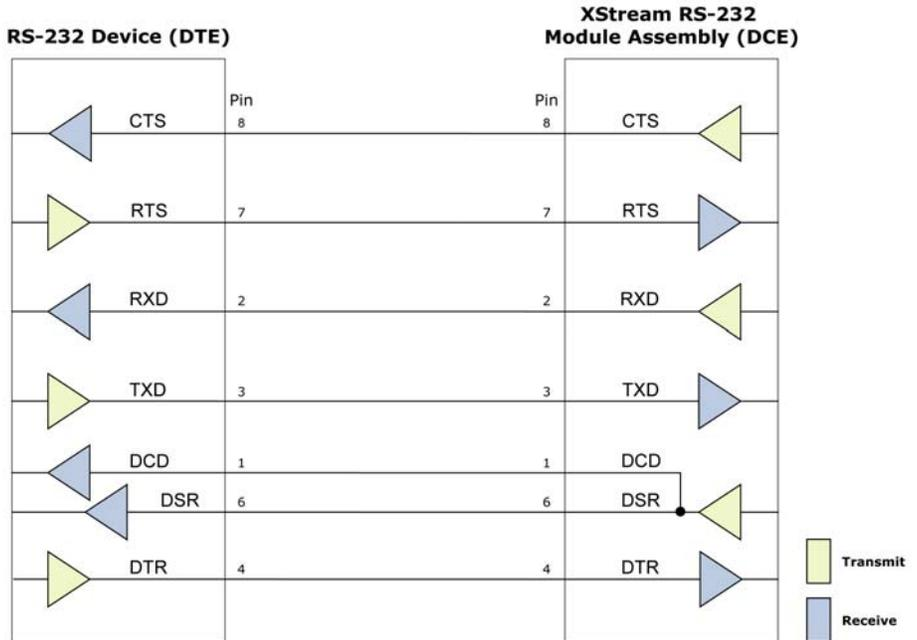

Wiring Diagram: DCE Module Assembly to an RS-232 DCE Device

Figure B-11. XStream Module Assembly (female connector) wired to an RS-232 DTE (male connector) device

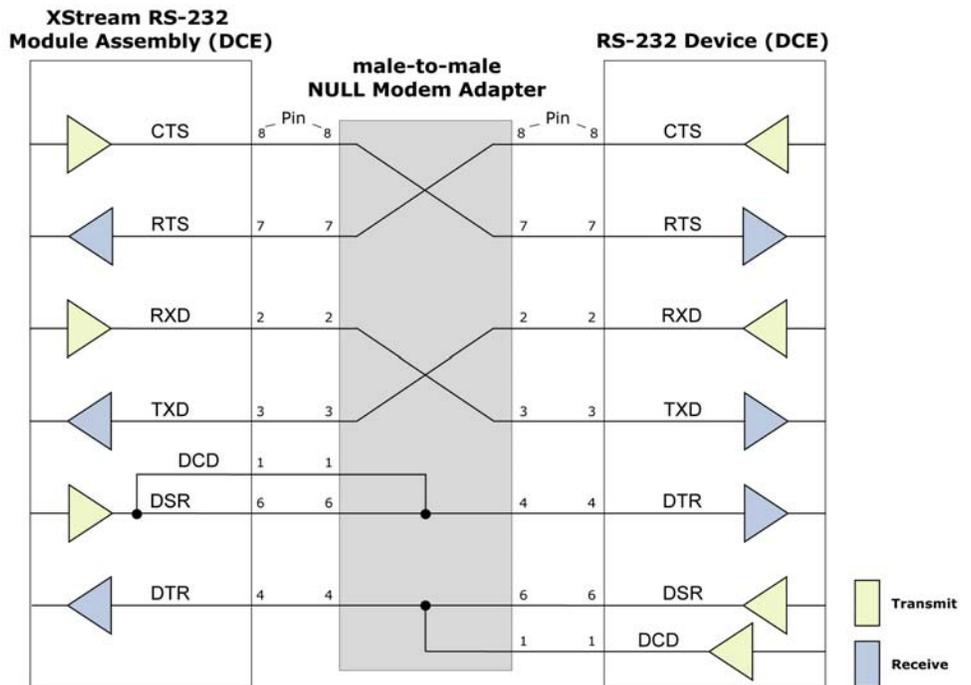

Sample Wireless Connection: DTE ↔ DCE ←-----→ DCE ↔ DCE

Figure B-12 Typical wireless connection used for serial communications between DTE and DCE devices

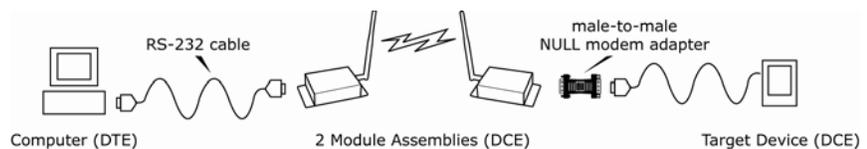

RS-485 (2-wire) Operation

DIP Switch Settings and Serial Port Connections

Figure B-13.
RS-485 (2-wire) Half-Duplex
DIP Switch Settings

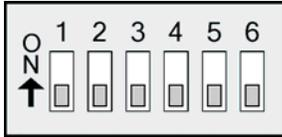
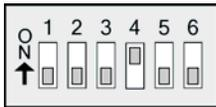

Figure B-15
RS-485 (2-wire) with Termination (optional)



Termination is the 120 Ω resistor between T+ and T-.

DIP Switch settings are read and applied only while powering-on.

Figure B-14.
Pins used on the female RS-232 (DB-9)
Serial Connector

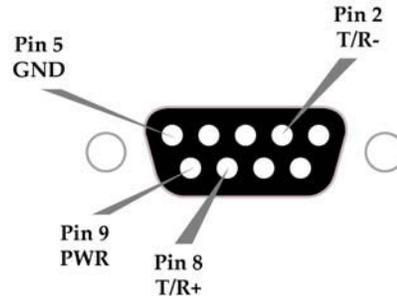

Note: Refer to Figure B-022 and Figure B-023 (p45) for RJ-45 connector pin designations used in RS-485/422 environments.

Table B-06. RS-485 (2-wire half-duplex) Signals and their implementations on the XStream Module Assembly

DB-9 Pin	RS-485 Name	Description	Implementation
2	T/R- (TRA)	Negative Data Line	Transmit serial data to and from the XStream Module Assembly
5	GND	Ground Signal	Ground
8	T/R+ (TRB)	Positive Data Line	Transmit serial data to and from the XStream Module Assembly
9	PWR	Power	Optional power input that is connected internally to the front power connector
1, 3, 4, 6, 7			not used

Wiring Diagram: RS-485 (2-wire) Half-Duplex

Figure B-16. XStream Module Assembly in an RS-485 (2-wire) half-duplex environment

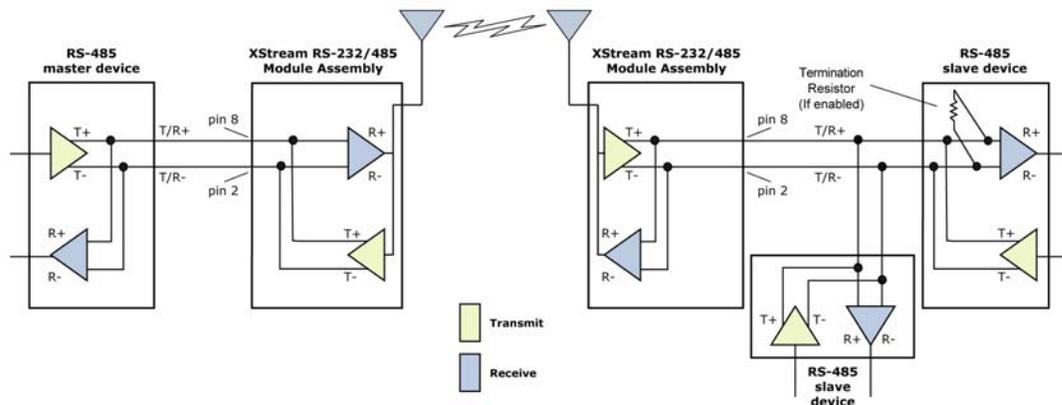

RS-485 (4-wire) and RS-422 Operation

DIP Switch Settings and Serial Port Connections

Figure B-17
RS-485 (4-wire) and RS-422
DIP Switch Settings

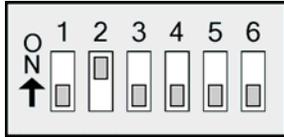
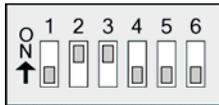

Figure B-19
RS-485 (4-wire) and RS-422 with Termination (option)



Termination is the 120 Ω resistor between T+ and T-.

DIP Switch settings are read and applied only while powering-on.

Figure B-18
Pins used on the female RS-232 (DB-9)
Serial Connector

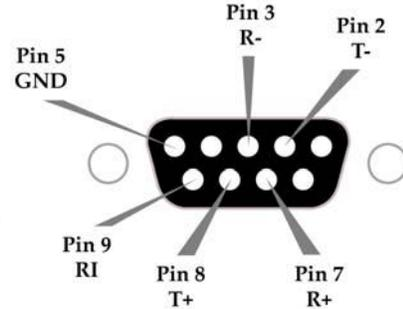
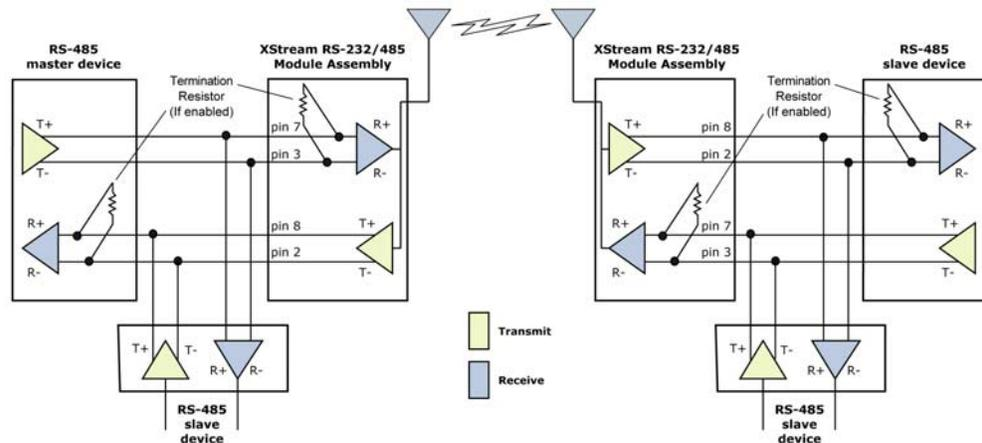

Table B-07. RS-485/422 (4-wire) Signals and their implementations with the Module Assembly

DB-9 Pin	RS-485/422 Name	Description	Implementation
2	T- (TA)	Transmit Negative Data Line	Serial data sent from the XStream Module Assembly
3	R- (RA)	Receive Negative Data Line	Serial data received by the XStream Module Assembly
5	GND	Signal Ground	Ground
7	R+ (RB)	Receive Positive Data Line	Serial data received by the XStream Module Assembly
8	T+ (TB)	Transmit Positive Data Line	Serial data sent from the XStream Module Assembly
9	PWR	Power	Optional power input that is connected internally to the front power connector
1, 4, 6			not used

Wiring Diagram: RS-485 (4-wire) Half-Duplex

Figure B-20. XStream Module Assembly in an RS-485 (4-wire) environment



Wiring Diagram: RS-422

Figure B-21. XStream Module Assembly in an RS-485 (4-wire) environment

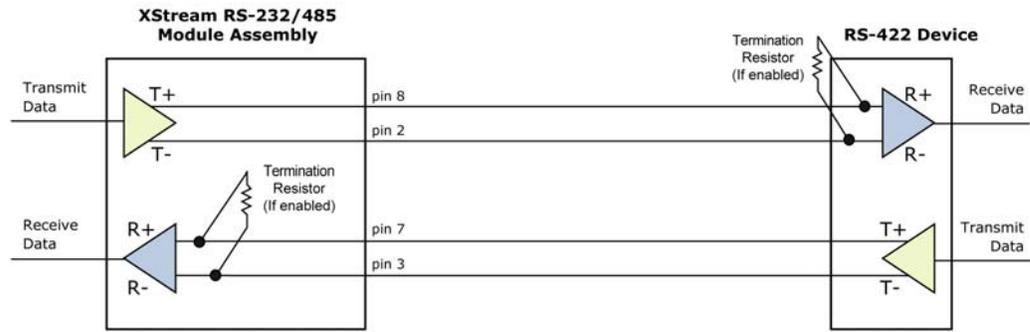

RS-485/422 Connection Guidelines

The RS-485/422 protocol provides a solution for wired communications that can tolerate high noise and push signals over long cable lengths. RS-485/422 signals can communicate as far as 4000 feet (1200 m). RS-232 signals are suitable for cable distances up to 100 feet (30.5 m).

RS-485 offers multi-drop capability in which up to 32 nodes can be connected. The RS-422 protocol is used for point-to-point communications.

Suggestions for integrating the XStream Module with the RS-485/422 protocol:

1. When using Ethernet twisted pair cabling: Select wires so that T+ and T- are connected to each wire in a twisted pair. Likewise, select wires so that R+ and R- are connected to a twisted pair. (For example, tie the green and white/green wires to T+ and T-.)
2. For straight-through Ethernet cable (not cross-over cable) – The following wiring pattern works well: Pin3 to T+, Pin4 to R+, Pin5 to R-, Pin6 to T-
3. Note that the connecting cable only requires 4 wires (even though there are 8 wires).
4. When using phone cabling (RJ-11) – Pin2 in the cable maps to Pin3 on opposite end of cable and Pin1 maps to Pin4 respectively.

Figure B-22 Male (yellow) DB-9 to RJ-45 Adapters

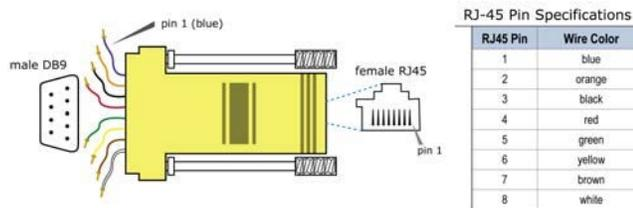
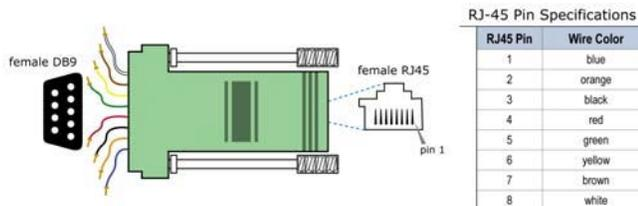

Figure B-23. Female (green) DB-9 to RJ-45 Adapters



XCTU Software

Using the XCTU Software

XCTU is Digi-provided software used to interface with and configure XStream OEM RF Modules. The software application is organized into the following four tabs:

- PC Settings tab - Setup PC serial ports to interface with an XStream Module assembly
- Range Test tab – Test XStream Module's range and monitor packets sent and received
- Terminal tab – Set and read XStream Module parameters using AT Commands
- Modem Configuration tab – Set and read XStream Module parameters

Figure B-24 X-CTU User Interface (PC Settings, Range Test, Terminal and Modem Configuration tabs)

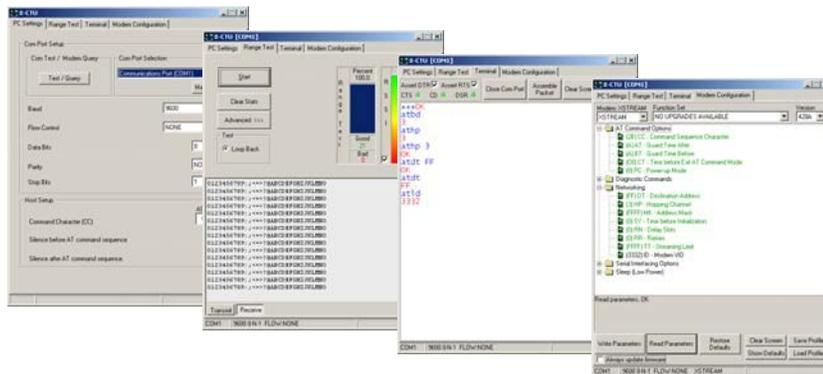

Install XCTU software

Navigate to: www.digi.com/support. Then select "XCTU" under the product list. Select the appropriate driver to install the XCTU software.

Setup

To use the XCTU software, a module assembly (XStream Module mounted to a Digi XIB- R-R Interface Board) must be connected to the serial port of a PC. The data rate and parity settings of the serial port ("PC Settings" tab) must match those of the module (BD (Baud Rate) and NB (Parity) Commands).

Serial Communications Software

A terminal program is built into the XCTU Software. Other terminal programs such as "HyperTerminal" can also be used. When issuing AT Commands through a terminal program interface, use the following syntax:

Figure B-25 Syntax for sending AT Commands:

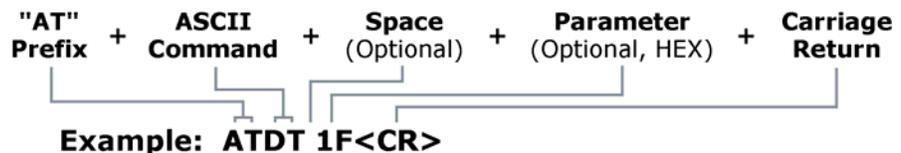

Note: To read a parameter value stored in a register, leave the parameter field blank.

The example above issues DT Command to change destination address of the module to "0x1F". To save the new value to the module's non-volatile (long term) memory, issue WR (Write) Command after modifying parameters

Appendix C: Additional Information

1-Year Warranty

XStream OEM RF Modules from Digi International Inc. (the "Product") are warranted against defects in materials and workmanship under normal use, for a period of 1-year from the date of purchase. In the event of a product failure due to materials or workmanship, Digi will repair or replace the defective product. For warranty service, return the defective product to Digi, shipping prepaid, for prompt repair or replacement.

The foregoing sets forth the full extent of Digi's warranties regarding the Product. Repair or replacement at Digi's option is the exclusive remedy. THIS WARRANTY IS GIVEN IN LIEU OF ALL OTHER WARRANTIES, EXPRESS OR IMPLIED, AND DIGI SPECIFICALLY DISCLAIMS ALL WARRANTIES OF MERCHANTABILITY OR FITNESS FOR A PARTICULAR PURPOSE. IN NO EVENT SHALL DIGI, ITS SUPPLIERS OR LICENSORS BE LIABLE FOR DAMAGES IN EXCESS OF THE PURCHASE PRICE OF THE PRODUCT, FOR ANY LOSS OF USE, LOSS OF TIME, INCONVENIENCE, COMMERCIAL LOSS, LOST PROFITS OR SAVINGS, OR OTHER INCIDENTAL, SPECIAL OR CONSEQUENTIAL DAMAGES ARISING OUT OF THE USE OR INABILITY TO USE THE PRODUCT, TO THE FULL EXTENT SUCH MAY BE DISCLAIMED BY LAW. SOME STATES DO NOT ALLOW THE EXCLUSION OR LIMITATION OF INCIDENTAL OR CONSEQUENTIAL DAMAGES. THEREFOR, THE FOREGOING EXCLUSIONS MAY NOT APPLY IN ALL CASES. This warranty provides specific legal rights. Other rights which vary from state to state may also apply.

Ordering Information

Figure C-01 Digi OEM RF Module Part Numbers Key

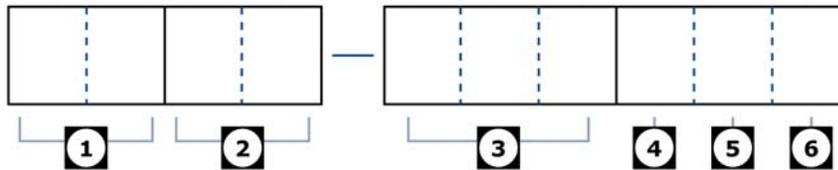

Divisions of the MaxStream OEM RF Module Part Number:

- | | |
|--------------------------------------------------------------------------------------------------------------------------------------------------------------------------------------------------------------------------------------------------------------------------------------------------------------------------------------------------------------|-------------------------------------------------------------------------------------------------------------------------------------------------------------------------------------------------------------------------------------------------------|
| <p>1 MaxStream Product Family
 XC = XCite
 X = XStream
 XT = XTend</p> | <p>4 Wire Antenna
 W = Wire Antenna
 N = No wire antenna</p> |
| <p>2 Operating Frequency
 09 = 902-928 MHz
 24 = 2.4000 - 2.4835 GHz
 (XStream only)
 H9 = 923 MHz (XStream only)</p> | <p>5 Antenna Connector
 S = RPSMA Connector
 M = MMCX
 N = No connector (wire antenna)</p> |
| <p>3 Throughput Data Rate
 001 = 1200 bps (XStream only)
 009 = 9600 bps
 019 = 19200 bps (XStream only)
 038 = 38400 bps (XCite Only)
 (blank) = All XTend RF Modems support 9600 & 115200 bps (software selectable)</p> | <p>6 Temperature Rating
 C = Commercial: 0 to 70° C
 I = Industrial: -40 to 85° C, conformal coated
 T = Tested: -40 to 85° C, conformal coating & 100% tested</p> |

Contact Digi

If you need assistance, contact technical support:

Documentation:	www.digi.com/support/
Technical Support:	Phone (866) 765-9885 toll-free U.S. and Canada (801) 765-9885 Worldwide 8:00 am – 5:00 pm (U.S. Mountain Time)
	Online www.digi.com/support/eservice