

Package Contents	Tools Required
<ul style="list-style-type: none"> In-Line Switch Module Antenna sleeve 	<ul style="list-style-type: none"> Screwdriver Wire nuts

Product Description

The In-Line Switch Module provides a simple and effective way to conserve energy and enhance convenience by intelligently switching lighting and other electrical loads.

The module communicates wirelessly with other EnOcean-based products used for occupancy detection and lighting control. The module is a line voltage control device compact enough to be mounted inside a standard electrical junction box or mounted to an electrical box or a lighting fixture through a standard knock-out using the threaded connector.

Features Include:

- Receives wireless messages from other devices to switch lighting or other electrical loads on/off
- Controls loads individually or as part of a scene or event
- Installs inside or mounts to electrical box using threaded connector
- Sends wireless messages to other controlled devices and configurable transceivers.

Specifications

Power Supply	120V - 277V VAC, 50/60 Hz
Maximum Load	General Purpose: 16A @ 120/277VAC Resistive: 16A @ 120/277VAC Motor: 1/2 HP @ 120VAC Tungsten: 960W @ 120VAC Ballast: 600W @ 120VAC
Power Consumption	1.1W full load, 500mW quiescent

Inputs/Outputs	<ul style="list-style-type: none"> Flying-lead style power input wires 1 normally open relay 1 switched output wire Radio Frequency (RF) transceiver 2 Buttons with LEDs for device configuration & manual control
RF Communications	EnOcean 902 MHz
Transmission Range	80 ft. (25 m)
Interoperable Products / EEPs (EnOcean Equipment Profiles)	Product Name (EEP #) Rocker Pad Switch (F6-02-02) Key Card Switch (F6-04-01) Window handle (F6-10-00) 1BS Single Input Contact (D5-00-01) Light Sensor, 0-1020 lux (A5-06-02) Occupancy Sensor (A5-07-01) Contact, single input (A5-30-01) Central Gateway (A5-38-08)
Dimensions	2.78" H x 1.65" W x 1.1" D (73mm x 42mm x 28mm)
Weight	3.2oz. (90g)
Mounting	<ul style="list-style-type: none"> Install inside standard electrical box Connect to electrical boxes and fixtures using threaded nipple
Environment	<ul style="list-style-type: none"> Indoor use only 32° to 104° F (0° to 44° C) 20% to 95% relative humidity (non-condensing)
Agency Compliance	ETL, FCC, IC

1. Planning

Take a moment to plan for the module's successful operation and optimal communication with other system components.

- Always use a qualified installer
- Install in an appropriate location
- Take care not to damage the radio antenna that runs in a groove on the outside of the module
- Consider the construction materials in the space and obstacles that may interfere with RF signals

2. Installing

estimated time: 20 minutes 

Read and understand instructions completely before starting.

	ELECTRICAL SHOCK HAZARD High Voltage. This device must be installed by a qualified installer or electrician. Follow all applicable electrical codes for installation.
---	---

1. Turn off power at the circuit breaker or fuse and test that power is off before wiring the device.

NOTE: Use a non-metal electrical enclosure for best wireless communication performance.

2. Identify the wiring connection at the installation site to coordinate with the following wiring diagram.

NOTE: For display purposes, white wire is shown as yellow.

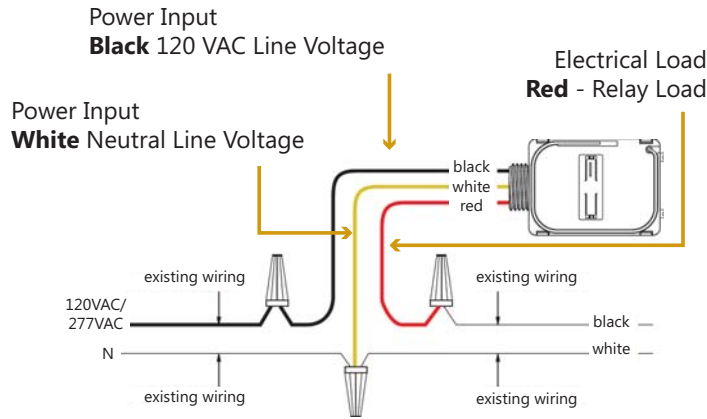

3. Determine which of the two installation methods is most appropriate:
 - A. Installed inside the electrical box.

NOTE: For best performance, remove the antenna from its slot and elongate it outside and away from the box.
 - B. Installed using the threaded connector:
 - i. Insert the threaded connector through a 1/2" diameter knockout.
 - ii. Thread the 3 module wires inside the electrical box and through the lock nut.

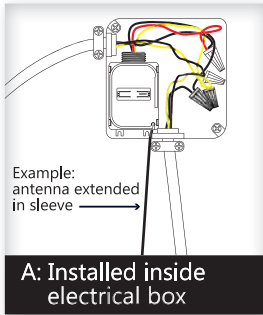

A: Installed inside electrical box

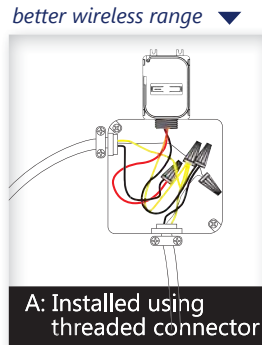

A: Installed using threaded connector

4. Connect the wires using wire nuts and cap any bare wires.

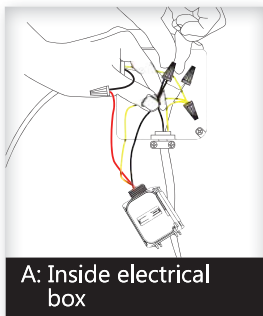

A: Inside electrical box

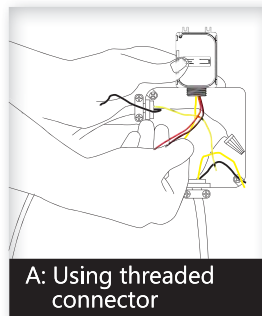

A: Using threaded connector

NOTE: After the module is linked and configured, you can secure it in the installed location, see step 8.

5. Fold the wires neatly and either place the module in the box or secure the threaded connector with the lock nut.
6. Position the module so that the setup interface and antenna face forward (out).

TIP: If the RF reception is poor, use the antenna sleeve provided to extend the antenna.
7. Restore power to the circuit.

The LEDs on the module will blink and then the right LED will display solid red when the relay is open or green when the relay is closed (switch on).
8. Use the setup interface to link devices and configure settings (refer to the "Linking" & "Configuring" sections).

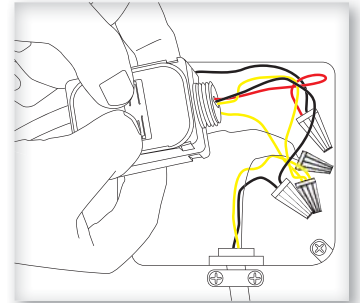

Warning: Remove the module from the electrical box to use the setup interface.

3. Linking

Two or more compatible devices can be linked and configured to provide the desired control. There are two basic types of devices in the system; transmitters and transceivers.

- **Transmit-only:** Transmitters are simple energy-harvesting devices that send RF messages to communicate a condition, level, or state. Transmitters can only be linked to transceivers. Examples > Self-powered Light Switches, Occupancy Sensors
- **Transmit & Receive:** Transceivers are controlling devices that send as well as receive RF messages. They also process relevant control logic, and actuate the appropriate outputs (switching a light on or off for example). Transceivers can be linked with transmitters as well as other transceivers. A transceiver can have up to 30 devices linked to it. Examples > Relays, Gateways

The In-Line Switch Module is a Transceiver (transmits & receives)

To link the In-Line Switch to a transmitter, the In-Line Switch must first be powered, within wireless range of the transmitter it is to be linked to, and set to accept links.

Next, the desired transmitter is triggered to send a special link message. The awaiting transceiver receives and stores the link permanently so the devices can interact to provide a variety of intelligent control options.

About the Setup Interface

The setup interface has two buttons, Menu and Set, that each have a corresponding 3-color LED (green, amber, red). This simple interface is used to link and configure devices as a system.

The buttons and LEDs are used to navigate and select linking and setup options through a 3-tier menu system consisting of different Modes > Menus > Options.

To use the interface, hold the module so both thumbs can click the buttons without obscuring the LEDs. The illustration and legend below describe how the buttons are used and the meaning of the LED responses.

To exit from anywhere in a menu, hold both buttons at the same time for 2 seconds.

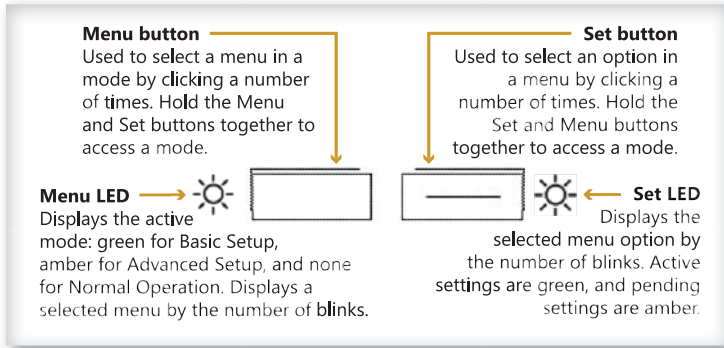

- The Menu LED or Set LED display solid for a number of seconds in a certain color to indicate a mode or a confirmation.
- The Menu LED blinks a number of times in a color to indicate a selected menu.
- The Set LED blinks a number of times in a color to indicate an option.
- A number in a white box indicates the number of times to click the Menu button or Set button.
- A number in a black box indicates the number of seconds to hold down the Menu button or Set button.

To link a transmitter to a transceiver

1. Access Basic Setup mode.

NOTE: By default, the Accept Link option in the Linking menu is selected. Once activated, this option stays active for two minutes to provide time to link multiple devices.

Ready to accept links.

2. For the transmitter to be linked, do one of the following according to the type of device:
 - A. Sensor: click the designated link button.
 - B. Key Card Switch: insert/remove the card 3 times quickly.
 - C. Rocker Pad: click the top button 3 times quickly.

Device linked successfully. Set LED displays solid green for 3 seconds.

Ready to accept new links.

3. To exit mode and return to normal operation, press and hold both buttons for 2 seconds.

To unlink a device

Follow the same steps as described in the “To link...” section above with the following deviations:

- After step 1 in the “To link...” section above, click the “Set” (right) button 3 times to enable the “Remove Link” option.

Ready to remove links.

- Follow the same instructions as shown in Step 2 of the “To link...” section. The Set (right) LED will turn red briefly to indicate the link was successfully removed.

To restore factory defaults

Follow these steps to clear all linked devices and restore the In-line Switch Module to its factory default settings.

1. Press and hold both buttons for 15 seconds >> Hold buttons until the Menu (left) LED is solid RED and the Set (right) LED is solid Amber (Both LEDs will turn various colors as the module cycles through the resetting process).
2. Press and hold the Set (right) button for 3 seconds to confirm factory reset.
3. Device will reboot and initiate start up LED sequence.

4. Configuring

The default settings on the module support common control and installation scenarios. However, some occupancy settings can be adjusted on the module using the setup interface, if required.

Setting	Default	Application
Auto-On	Automatically Determined	If linked to an occupancy sensor, the default is Enabled. If linked to a switch, the default is Disabled for manual control.
Vacancy Check	5 minutes	If linked to a occupancy sensor and a door sensor.
Switched Auto-Off	Disabled	If linked to a rocker pad or key card switch.
Motion Auto-Off	15 minutes	If linked to occupancy sensor.
Door/Window Ajar	2 minutes	If linked to an occupancy sensor.
Egress	30 seconds	If linked to a key card switch.

Auto-Off

There are two auto-off menus, one for occupancy sensors, and one for rocker switches. For linked occupancy sensors, the default is 15 minutes. For linked rocker pads and key card switches, the default is Disabled to allow manual control.

From the auto-off timer menu, the active option is indicated by the number of green blinks on the Set LED; amber blinks indicate an unsaved change. Click the Set button an appropriate number of times to select an option.

Option	Clicks	Blinks
Disabled		
5 mins.		
15 mins.		
30 mins.		
60 mins.		

To change the switched auto-off option:

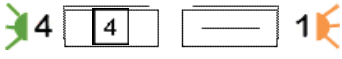
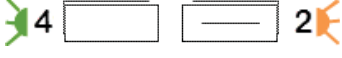
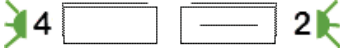

This example shows changing the option from Disabled to 5 minutes.

1. Access Basic Setup mode.

2. Select the Switched Auto-Off menu. 
3. Select an option. 
4. Save the selection. 

To change the motion auto-off option:

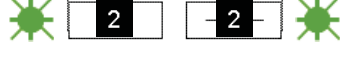
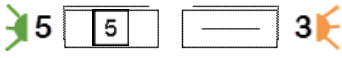
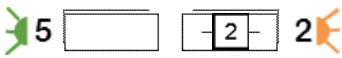



This example shows changing the option from 15 to 5 minutes.

1. Access Basic Setup mode. 
2. Select the Motion Auto-Off menu. 
3. Select an option. 
4. Save the selection. 

Vacancy Check



Vacancy check is a time delay activated when a door opens and closes. Linked loads will turn off if any motion sensor(s) does not confirm occupancy within the time delay.

From the Vacancy Check menu, the active option is indicated by the number of green blinks on the Set LED; amber blinks indicate an unsaved change. Click the Set button an appropriate number of times to select an option.

Option	Clicks	Blinks
5 mins. (default)	1	1 
15 minutes	2	2 
30 minutes	3	3 
60 minutes	4	4 
120 minutes	5	5 

To change the vacancy check option:

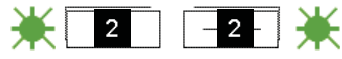
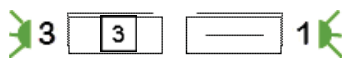

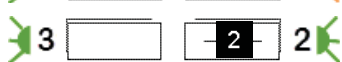
This example shows changing the option from 5 to 15 minutes.

1. Access Basic Setup mode. 
2. Select the Vacancy Check menu. 
3. Select an option. 
4. Save the selection. 

To enable the device as a repeater

In some situations, enabling the transceiver device as a repeater can help optimize the wireless range between devices.

1. Access Advanced Setup by holding both buttons down for 5 seconds and releasing them when both LEDs turn amber.
2. Click the Set button an appropriate number of times to select an option. >> By default, the first menu option in advanced setup is to Enable Repeater.

Option	Clicks	Blinks
Disabled (default)	1	1 
1 Hop	2	2 
2 Hops	3	3 

Example: Setting a device to operate as a repeater.

1. Access the Advanced setup (hold down both buttons for 5 seconds - until both LEDs turn amber).
2. Select "option 2" by clicking the Set (right) button two times. (Set button LED will blink 2x (amber) to confirm)
3. Save selection by holding Set button for 2 seconds.
4. Exit Menu (hold both buttons for 2 seconds.)
5. Re-boot module by either power cycling or pressing and holding both buttons for 10 seconds (release when Left LED=Red, Right LED=Green).

Troubleshooting

Problem	Solution Checklist
The device does not power up	<ul style="list-style-type: none"> Check the wiring for errors Check the circuit breaker Use a voltage meter to confirm power
The device does not control linked load	<ul style="list-style-type: none"> Click the Set button to open/close the relay manually Turn off the power and then restore it
Cannot link other devices	<ul style="list-style-type: none"> Check if Accept Link option can be accessed Move closer to the device; it may be out of range Try linking a different device Check for environmental conditions that interfere with RF signals Verify the maximum number of devices (30) has not been exceeded
Cannot change settings on the device	<ul style="list-style-type: none"> Check if menu item can be accessed Check if changes can be saved
The device does not respond to wireless messages or selected settings	<ul style="list-style-type: none"> Check for environment or range issues Verify the device is linked Check if appropriate devices are linked according to good system planning Extend the antenna to amplify the range: remove it from the groove in the module, straighten it and slide it into the white antenna sleeve provided



Contains: 902 MHz: FCC: SZV-STM300U
IC: 5713A-STM300U
UL E315672

This device complies with part 15 of the FCC rules and Industry Canada ICES-003. Operation is subject to the following two conditions: (1) This device may not cause harmful interference, and (2) this device must accept any interference received, including interference that may cause undesired operation.

IMPORTANT! Any changes or modifications not expressly approved by the party responsible for compliance could void the user's authority to operate this equipment.

Le présent appareil est conforme aux CNR d'Industrie Canada applicables aux appareils radio exempts de licence. L'exploitation est autorisée aux deux conditions suivantes: (1) l'appareil ne doit pas produire de brouillage, et (2) l'utilisateur de l'appareil doit accepter tout brouillage radioélectrique subi, même si le brouillage est susceptible d'en compromettre le fonctionnement.

IMPORTANT! Tous les changements ou modifications pas expressément approuvés par la partie responsable de la conformité ont pu vider l'autorité de l'utilisateur pour actionner cet équipement.

Limited Warranty

ONE YEAR