

Specifications:

Sound level Category	Medium Sound Level
Mode of Operation	Slow Pulse
Mounting	Panel (see note B)
Voltage Rating	30 to 120 Vac/dc
Frequency	1900 Hz ±300 Hz
Loudness (Min. Voltage)	60 dB(A) min. @ 2 FT and 30 Vac/dc
Loudness (Max Voltage)	75 dB(A) min. @ 2FT and 120 Vac/dc
Current Draw	6 mA Max @ 30 Vac/dc
Current Draw	20 mA Max @ 120 Vac/dc
Min. Pulse Rate (PPS)	0.5 @ 30 Vac/dc
Max. Pulse Rate (PPS)	2.0 @ 120 Vac/dc
Duty Cycle (%)	50 (Approx)
Storage Temperature	-40°C to +85°C
Operating Temperature	-30°C to +65°C
Weight (Typical)	2.7 oz (76 g)
Housing	6/6 Nylon, Color Black
Options	For other options contact factory

Dimensions: Inches (mm)

UL Recognized 

RoHS Compliant

PART DIMENSIONS BEFORE CODE DATE 0809 5

PART DIMENSIONS AFTER CODE DATE 0810 1

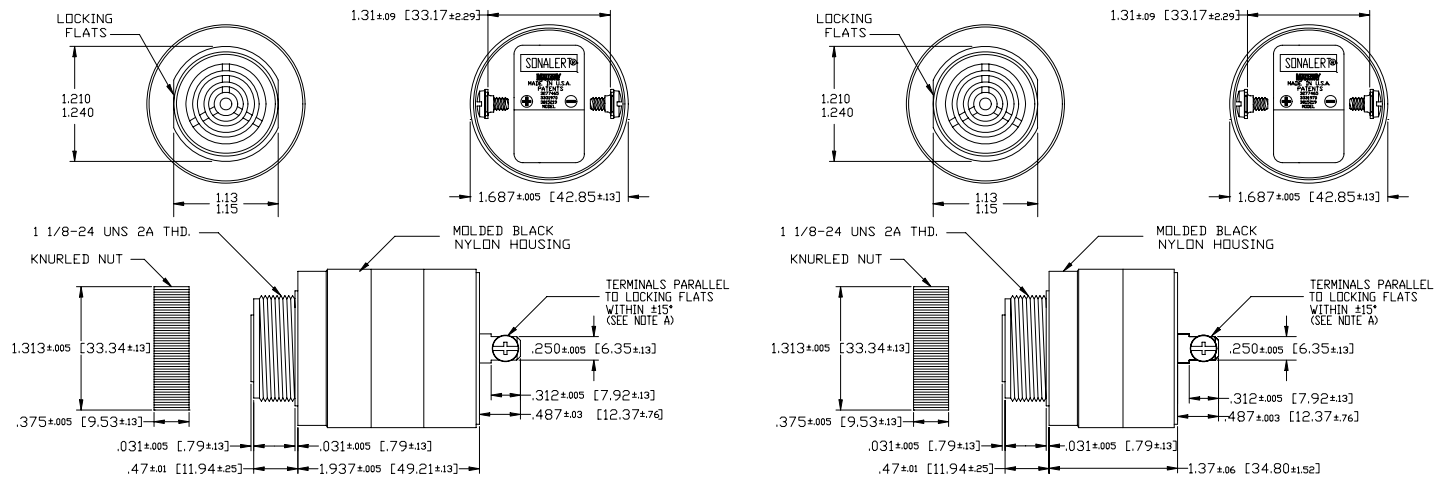

NOTE A: TERMINALS-.032 BRASS TIN PLATED, TAPPED FOR #6-32 SCREW. TWO #6-32 NICKEL PLATED BRASS SCREWS INCLUDED. WILL ACCEPT 1/4" QUICK CONNECT.

NOTE B: MOUNTING- REMOVE BLACK PLASTIC NUT AND INSERT THREADED FRONT THROUGH 1.25" HOLE PUNCHED IN PANEL. IF ORIENTATION IS NEEDED, NOTE LOCKING FLATS ON DRAWING. SCREW NUT BACK ON. DO NOT OVERTIGHTEN.

NOTE A: TERMINALS-.032 BRASS TIN PLATED, TAPPED FOR #6-32 SCREW. TWO #6-32 NICKEL PLATED BRASS SCREWS INCLUDED. WILL ACCEPT 1/4" QUICK CONNECT.

NOTE B: MOUNTING- REMOVE BLACK PLASTIC NUT AND INSERT THREADED FRONT THROUGH 1.25" HOLE PUNCHED IN PANEL. IF ORIENTATION IS NEEDED, NOTE LOCKING FLATS ON DRAWING. SCREW NUT BACK ON. DO NOT OVERTIGHTEN.