

# MUR3020WT, MUR3040WTG, MUR3060WT

## SWITCHMODE™ Power Rectifiers

These state-of-the-art devices are designed for use in switching power supplies, inverters and as free wheeling diodes.

### Features

- Ultrafast 35 and 60 Nanosecond Recovery Time
- 175°C Operating Junction Temperature
- Popular TO-247 Package
- High Voltage Capability to 600 V
- Low Forward Drop
- Low Leakage Specified @ 150°C Case Temperature
- Current Derating Specified @ Both Case and Ambient Temperatures
- Epoxy Meets UL 94 V-0 @ 0.125 in
- High Temperature Glass Passivated Junction
- Pb-Free Packages are Available\*

### Mechanical Characteristics:

- Case: Epoxy, Molded
- Weight: 4.3 Grams (Approximately)
- Finish: All External Surfaces Corrosion Resistant and Terminal Leads are Readily Solderable
- Lead Temperature for Soldering Purposes: 260°C Max. for 10 Seconds
- Shipped 30 Units Per Plastic Tube



**ON Semiconductor®**

<http://onsemi.com>

## ULTRAFAST RECTIFIERS 30 AMPERES, 200-600 VOLTS

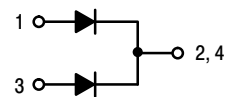

### MARKING DIAGRAM

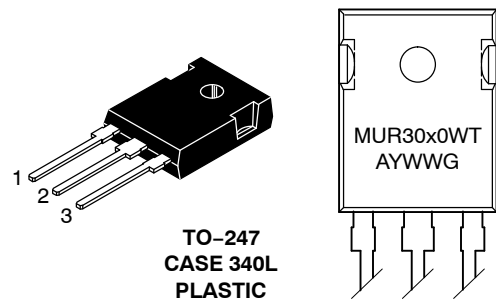

MUR30x0WT = Device Code  
 x = 2, 4 or 6  
 A = Assembly Location  
 Y = Year  
 WW = Work Week  
 G = Pb-Free Package

### ORDERING INFORMATION

Device	Package	Shipping
MUR3020WT	TO-247	30 Units/Rail
MUR3020WTG	TO-247 (Pb-Free)	30 Units/Rail
MUR3040WTG	TO-247 (Pb-Free)	30 Units/Rail
MUR3060WT	TO-247	30 Units/Rail
MUR3060WTG	TO-247 (Pb-Free)	30 Units/Rail

\*For additional information on our Pb-Free strategy and soldering details, please download the ON Semiconductor Soldering and Mounting Techniques Reference Manual, SOLDERRM/D.

# MUR3020WT, MUR3040WTG, MUR3060WT

## MAXIMUM RATINGS (Per Leg)

Rating	Symbol	MUR3020WT	MUR3040WT	MUR3060WT	Unit
Peak Repetitive Reverse Voltage Working Peak Reverse Voltage DC Blocking Voltage	$V_{RRM}$ $V_{RWM}$ $V_R$	200	400	600	V
Average Rectified Forward Current @ 145°C Total Device	$I_{F(AV)}$	15 30			A
Peak Repetitive Surge Current (Rated $V_R$ , Square Wave, 20 kHz, $T_C = 145^\circ\text{C}$ )	$I_{FM}$	30			A
Nonrepetitive Peak Surge Current (Surge applied at rated load conditions, halfwave, single phase, 60 Hz)	$I_{FSM}$	200	150	150	A
Operating Junction and Storage Temperature	$T_J, T_{stg}$	- 65 to +175			°C

## THERMAL CHARACTERISTICS (Per Leg)

Maximum Thermal Resistance, - Junction-to-Case - Junction-to-Ambient	$R_{\theta JC}$ $R_{\theta JA}$	1.5 40			°C/W
--	------------------------------------	-----------	--	--	------

## ELECTRICAL CHARACTERISTICS (Per Leg)

Maximum Instantaneous Forward Voltage (Note 1) ( $I_F = 15$ Amp, $T_C = 150^\circ\text{C}$ ) ( $I_F = 15$ Amp, $T_C = 25^\circ\text{C}$ )	$V_F$	0.85 1.05	1.12 1.25	1.4 1.7	V
Maximum Instantaneous Reverse Current (Note 1) (Rated DC Voltage, $T_J = 150^\circ\text{C}$ ) (Rated DC Voltage, $T_J = 25^\circ\text{C}$ )	$i_R$	500 10	500 10	1000 10	$\mu\text{A}$
Maximum Reverse Recovery Time ( $i_F = 1.0$ A, $di/dt = 50$ Amps/ $\mu\text{s}$ )	$t_{rr}$	35	60	60	ns

1. Pulse Test: Pulse Width = 300  $\mu\text{s}$ , Duty Cycle  $\leq 2.0\%$ .

# MUR3020WT, MUR3040WTG, MUR3060WT

## MUR3020WT

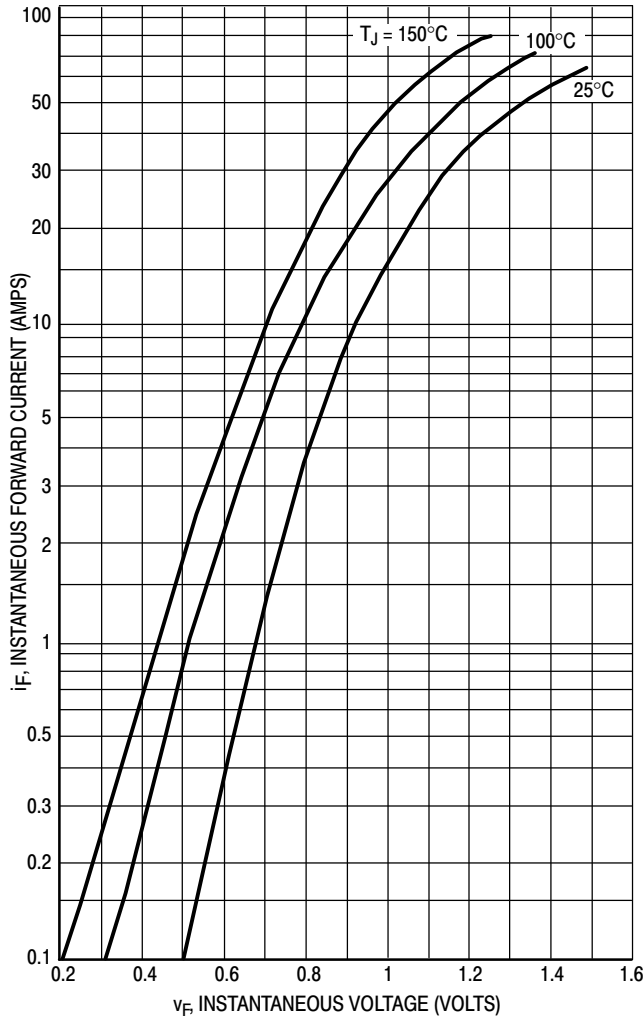
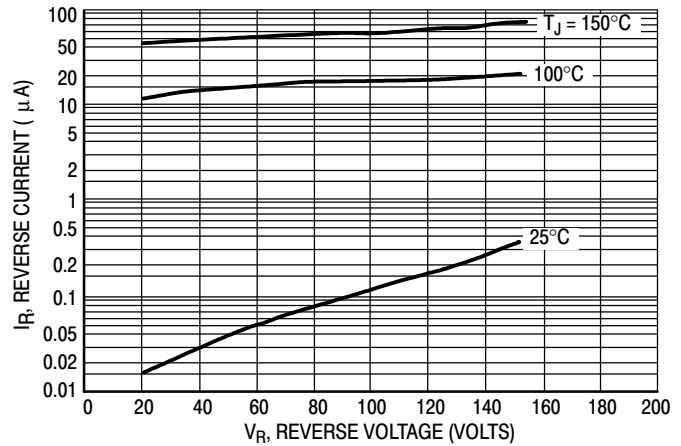

Figure 1. Typical Forward Voltage (Per Leg)



\*The curves shown are typical for the highest voltage device in the voltage grouping. Typical reverse current for lower voltage selections can be estimated from these same curves if  $V_R$  is sufficiently below rated  $V_R$ .

Figure 2. Typical Reverse Current (Per Leg)\*

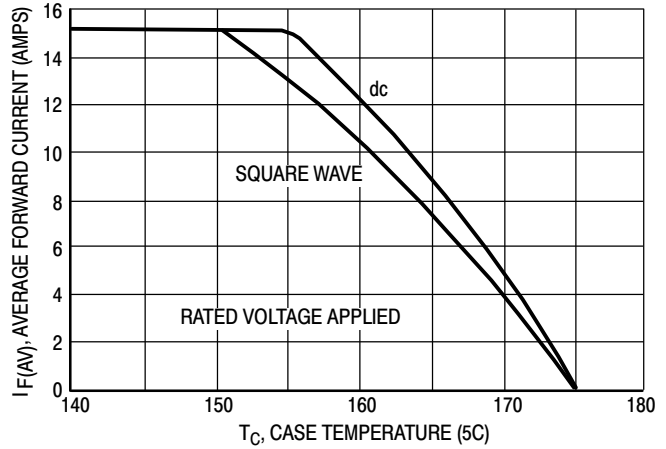

Figure 3. Current Derating, Case (Per Leg)

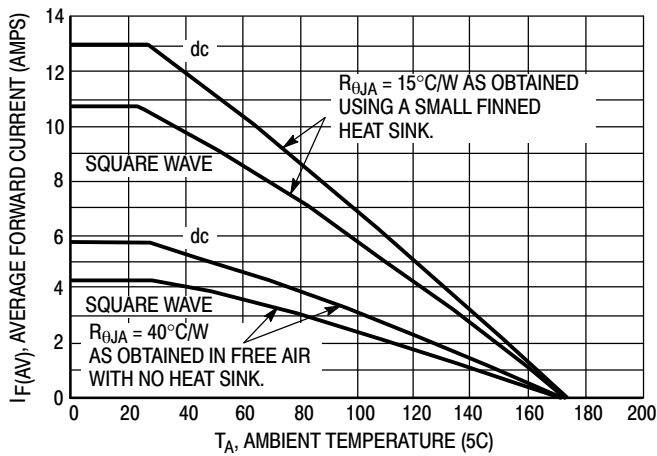

Figure 4. Current Derating, Ambient (Per Leg)

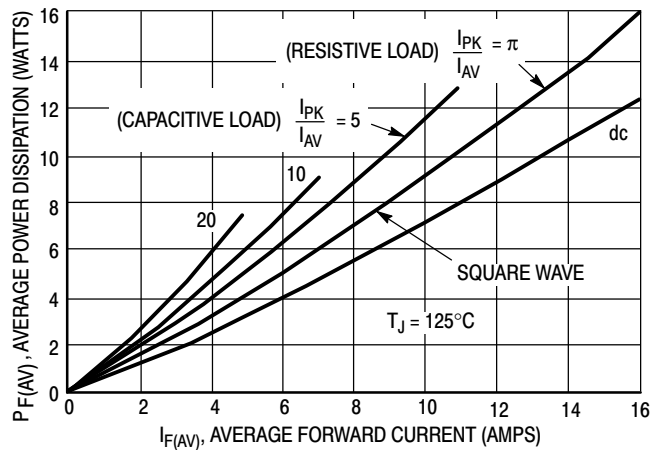

Figure 5. Power Dissipation (Per Leg)

MUR3040WTG

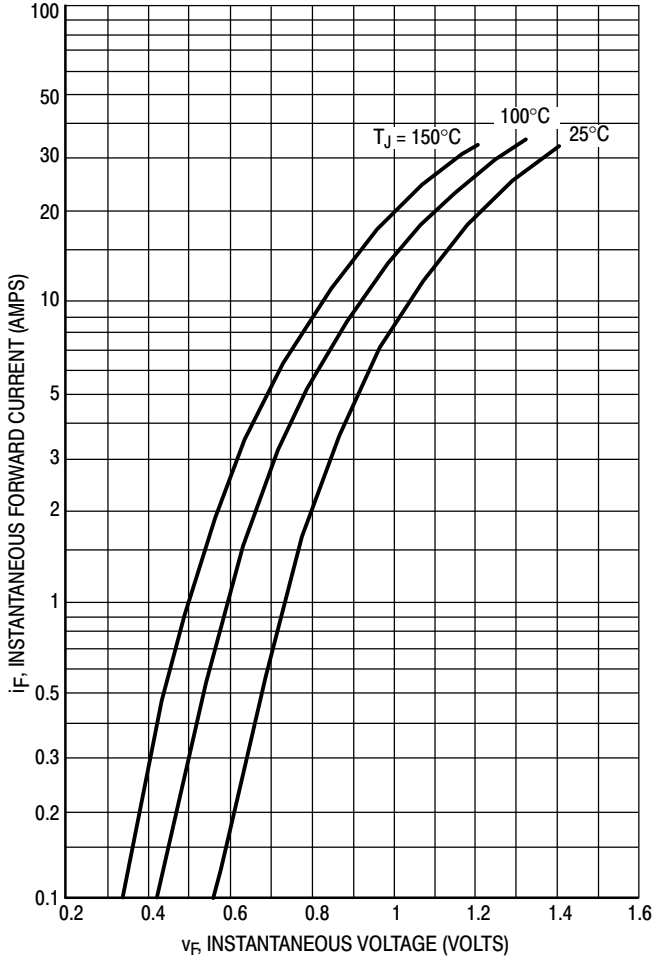
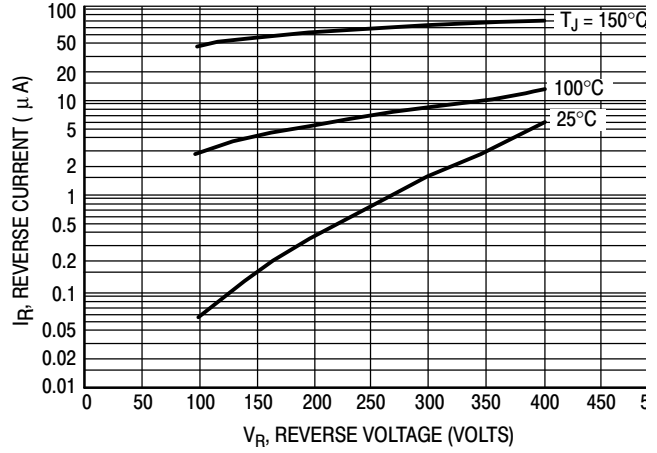

Figure 6. Typical Forward Voltage (Per Leg)



\*The curves shown are typical for the highest voltage device in the voltage grouping. Typical reverse current for lower voltage selections can be estimated from these same curves if  $V_R$  is sufficiently below rated  $V_R$ .

Figure 7. Typical Reverse Current (Per Leg)\*

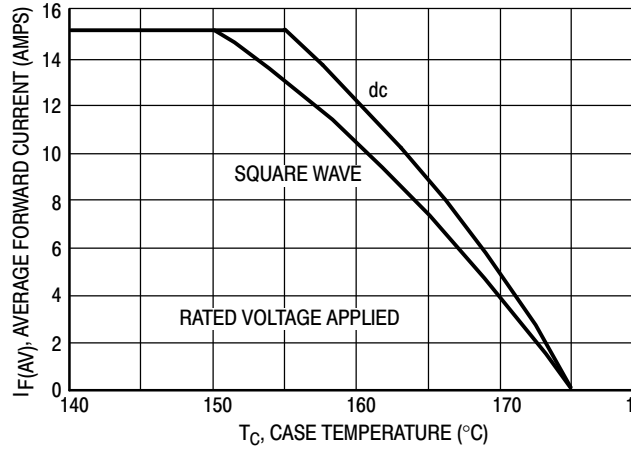

Figure 8. Current Derating, Case (Per Leg)

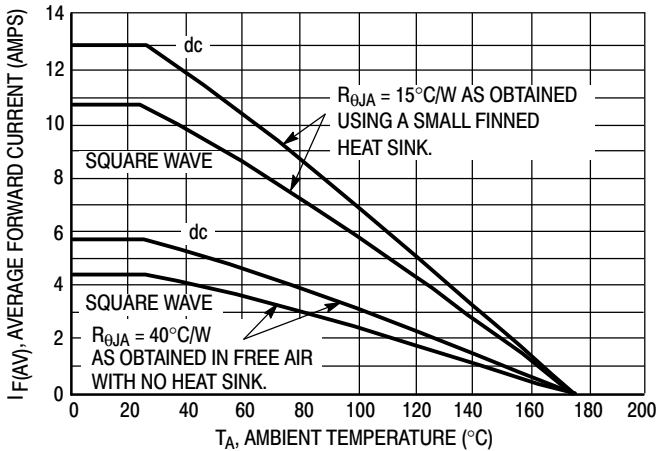

Figure 9. Current Derating, Ambient (Per Leg)

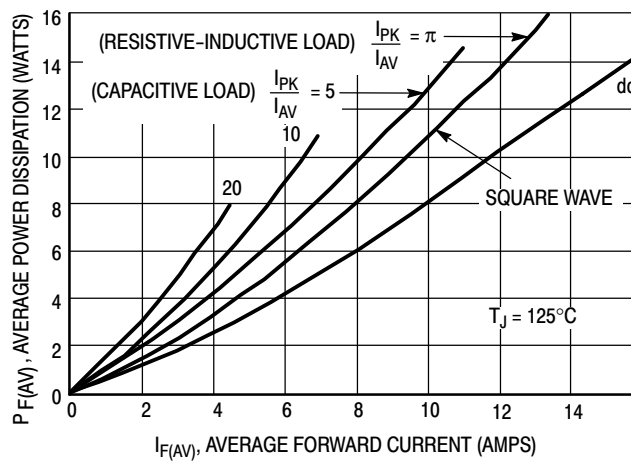

Figure 10. Power Dissipation (Per Leg)

MUR3020WT, MUR3040WTG, MUR3060WT

MUR3060WT

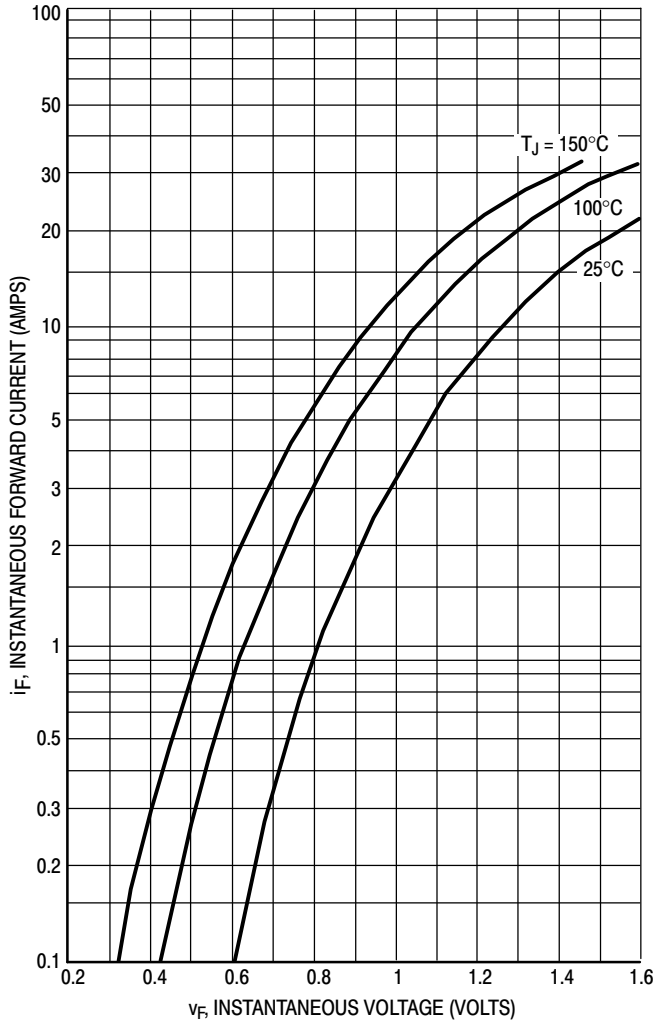
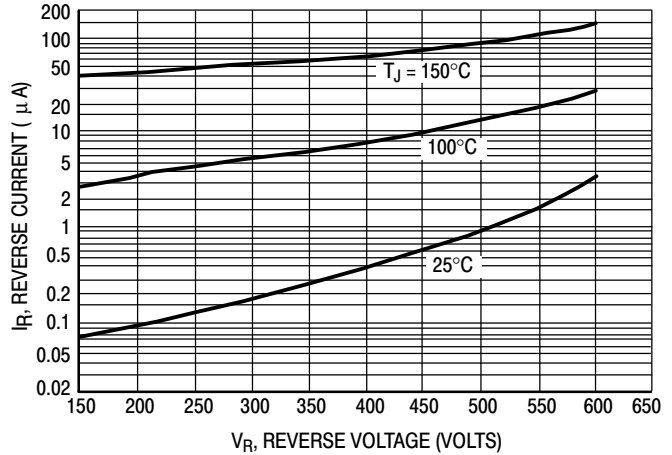

Figure 11. Typical Forward Voltage (Per Leg)



\*The curves shown are typical for the highest voltage device in the voltage grouping. Typical reverse current for lower voltage selections can be estimated from these same curves if  $V_R$  is sufficiently below rated  $V_R$ .

Figure 12. Typical Reverse Current (Per Leg)\*

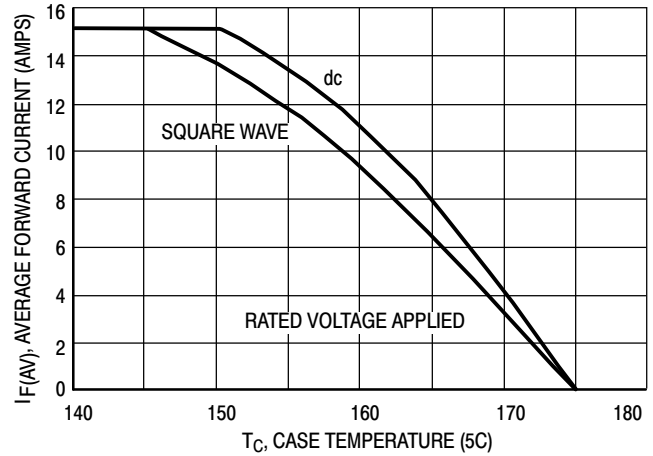

Figure 13. Current Derating, Case (Per Leg)

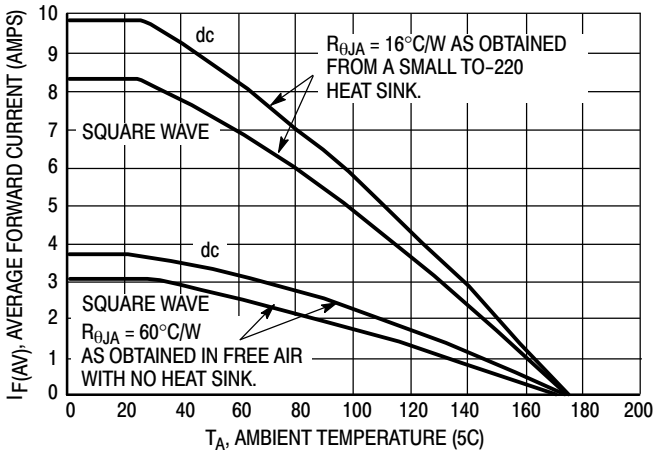

Figure 14. Current Derating, Ambient (Per Leg)

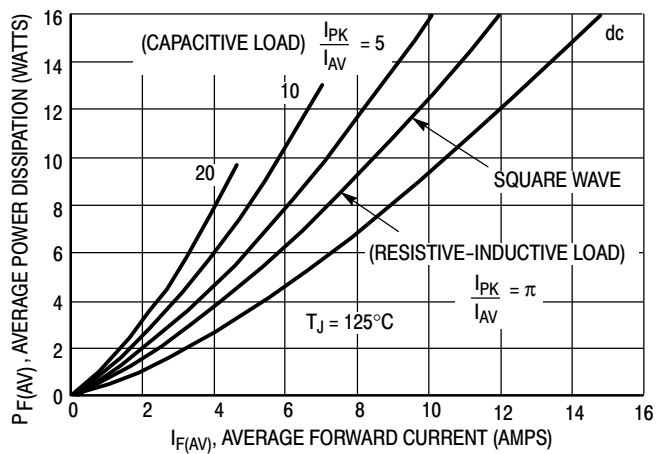

Figure 15. Power Dissipation (Per Leg)

MUR3020WT, MUR3040WTG, MUR3060WT

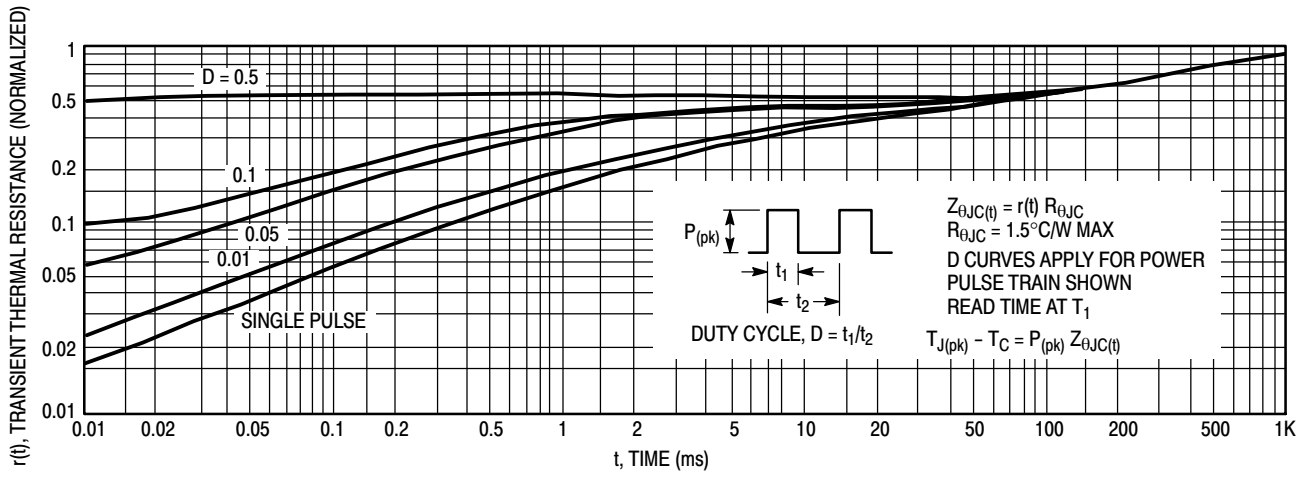

Figure 16. Thermal Response

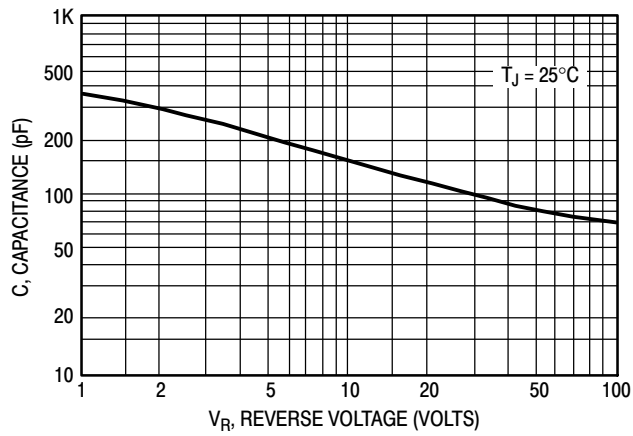
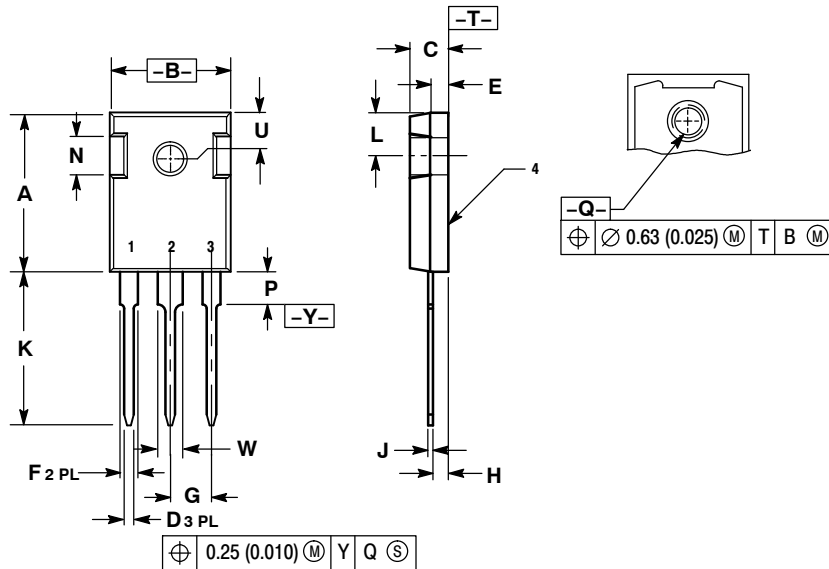

Figure 17. Typical Capacitance (Per Leg)

# MUR3020WT, MUR3040WTG, MUR3060WT

## PACKAGE DIMENSIONS

TO-247  
CASE 340L-02  
ISSUE E



NOTES:

1. DIMENSIONING AND TOLERANCING PER ANSI Y14.5M, 1982.
2. CONTROLLING DIMENSION: MILLIMETER.

DIM	MILLIMETERS		INCHES	
	MIN	MAX	MIN	MAX
A	20.32	21.08	0.800	0.830
B	15.75	16.26	0.620	0.640
C	4.70	5.30	0.185	0.209
D	1.00	1.40	0.040	0.055
E	1.90	2.60	0.075	0.102
F	1.65	2.13	0.065	0.084
G	5.45 BSC		0.215 BSC	
H	1.50	2.49	0.059	0.098
J	0.40	0.80	0.016	0.031
K	19.81	20.83	0.780	0.820
L	5.40	6.20	0.212	0.244
N	4.32	5.49	0.170	0.216
P	---	4.50	---	0.177
Q	3.55	3.65	0.140	0.144
U	6.15 BSC		0.242 BSC	
W	2.87	3.12	0.113	0.123

SWITCHMODE is a trademark of Semiconductor Components Industries, LLC.

ON Semiconductor and are registered trademarks of Semiconductor Components Industries, LLC (SCILLC). SCILLC reserves the right to make changes without further notice to any products herein. SCILLC makes no warranty, representation or guarantee regarding the suitability of its products for any particular purpose, nor does SCILLC assume any liability arising out of the application or use of any product or circuit, and specifically disclaims any and all liability, including without limitation special, consequential or incidental damages. "Typical" parameters which may be provided in SCILLC data sheets and/or specifications can and do vary in different applications and actual performance may vary over time. All operating parameters, including "Typicals" must be validated for each customer application by customer's technical experts. SCILLC does not convey any license under its patent rights nor the rights of others. SCILLC products are not designed, intended, or authorized for use as components in systems intended for surgical implant into the body, or other applications intended to support or sustain life, or for any other application in which the failure of the SCILLC product could create a situation where personal injury or death may occur. Should Buyer purchase or use SCILLC products for any such unintended or unauthorized application, Buyer shall indemnify and hold SCILLC and its officers, employees, subsidiaries, affiliates, and distributors harmless against all claims, costs, damages, and expenses, and reasonable attorney fees arising out of, directly or indirectly, any claim of personal injury or death associated with such unintended or unauthorized use, even if such claim alleges that SCILLC was negligent regarding the design or manufacture of the part. SCILLC is an Equal Opportunity/Affirmative Action Employer. This literature is subject to all applicable copyright laws and is not for resale in any manner.

### PUBLICATION ORDERING INFORMATION

**LITERATURE FULFILLMENT:**  
Literature Distribution Center for ON Semiconductor  
P.O. Box 5163, Denver, Colorado 80217 USA  
**Phone:** 303-675-2175 or 800-344-3860 Toll Free USA/Canada  
**Fax:** 303-675-2176 or 800-344-3867 Toll Free USA/Canada  
**Email:** orderlit@onsemi.com

**N. American Technical Support:** 800-282-9855 Toll Free  
USA/Canada  
**Europe, Middle East and Africa Technical Support:**  
Phone: 421 33 790 2910  
**Japan Customer Focus Center**  
Phone: 81-3-5773-3850

**ON Semiconductor Website:** [www.onsemi.com](http://www.onsemi.com)  
**Order Literature:** <http://www.onsemi.com/orderlit>

For additional information, please contact your local Sales Representative

**MUR3020WT/D**