

**Product number C10710_CUTE-3-S**

Family	Cute	FWHM	11 degrees
Type	Lens array	Efficiency	-
LED	Platinum Dragon	cd/lm	-
Color	Clear	Gerber File	Available
Diameter	35 mm		
Height	15 mm		
Style	Round		
Optic Material	PMMA		
Holder Material	-		
Fastening	["pin", "glue"]		
Status	Production ready		

Product number C10711_CUTE-3-M

Family	Cute	FWHM	28 degrees
Type	Lens array	Efficiency	-
LED	Platinum Dragon	cd/lm	-
Color	Clear	Gerber File	Available
Diameter	35 mm		
Height	15 mm		
Style	Round		
Optic Material	PMMA		
Holder Material	-		
Fastening	["pin", "glue"]		
Status	Production ready		

Product number C10712_CUTE-3-W

Family	Cute	FWHM	32 degrees
Type	Lens array	Efficiency	-
LED	Platinum Dragon	cd/lm	-
Color	Clear	Gerber File	Available
Diameter	35 mm		
Height	15 mm		
Style	Round		
Optic Material	PMMA		
Holder Material	-		
Fastening	["pin", "glue"]		
Status	Production ready		

NOTE: The typical divergence will be changed by different color, chip size and chip position tolerance. The typical total divergence is the full angle measured where the luminous intensity is half of the peak value.



PRODUCT DATASHEET

Cute series

last update 26/6/2013

GENERAL INFORMATION

- Product series especially designed & optimized for Platinum Dragon series of LEDs.
- Special care taken to make light distribution as uniform as possible.
- Lens material optical grade PMMA with high UV and temperature resistance. Allows use of high current and temperature conditions.

Please find more information about used material from below:

http://ledil.fi/sites/default/files/Documents/Technical/Material/PMMA%20N%20UL94_Yellow%20Card.pdf

<http://ledil.fi/sites/default/files/Documents/Technical/Material/PMMA%20N%20PLEXIGLAS-Datasheet.pdf>

Relative intensity of C10712_Cute-3-O-Plus-W

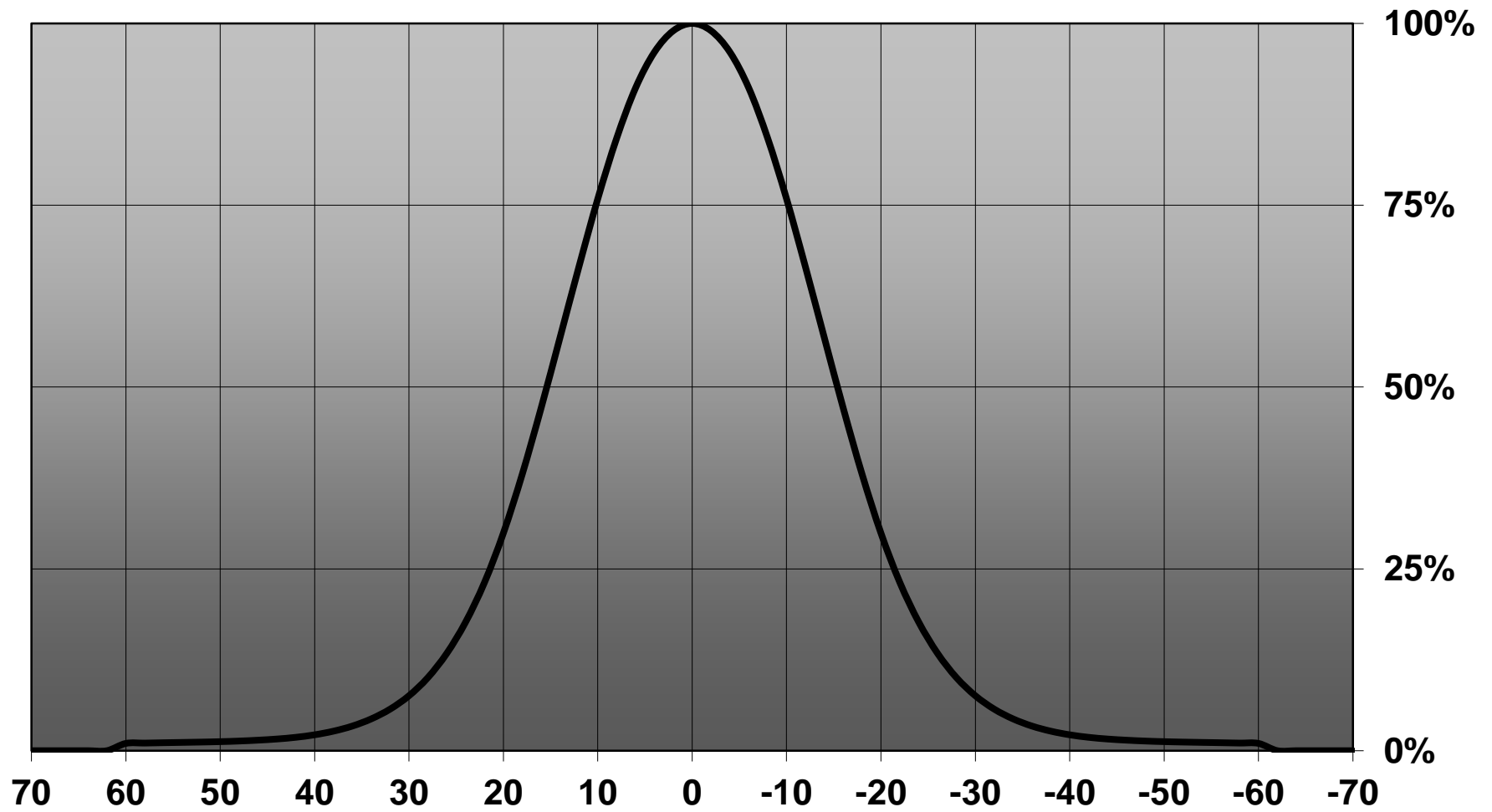

D

C

B

A

4

3

2

1

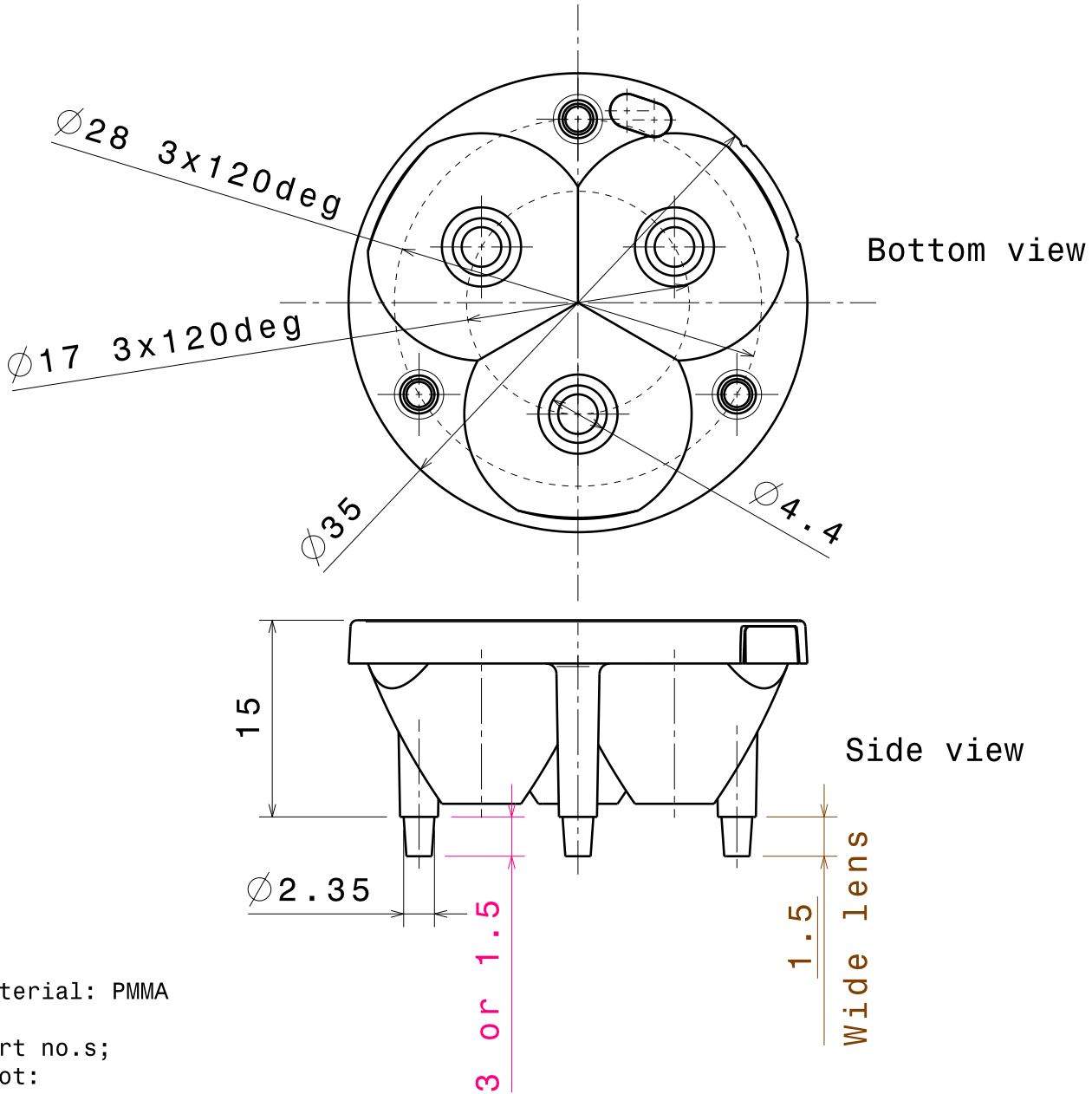

Material: PMMA

Part no.s;
 Spot:
 C10754_Cute-3-SS
 C11333_Cute-3-SS, pin head length =1.5mm
 Medium:
 C10755_Cute-3-M
 C11334_Cute-3-M, pin head length =1.5mm
 Wide:
 C10756_Cute-3-W

This drawing is our property.
 It can't be reproduced
 or communicated without
 our written agreement.



Ledil Oy
 Tehdaskatu 13
 FIN-24100 SALO
 Finland

DRAWING TITLE

Datasheet Cute-3 Lens Series

DRAWN BY pv	DATE 08.02.2010
----------------	--------------------

CHECKED BY TK	DATE 09.09.2008
------------------	--------------------

DESIGNED BY HH	DATE 09.09.2008
-------------------	--------------------

SIZE A4	DRAWING NUMBER	REV 1
SCALE 2:1	WEIGHT (g)	SHEET 1/1

D

A

1

Ledil Oy C10710_Cute-3-O-Plus-S C10710_Cute-3-O-Plus-S / LDC (Linear)

Luminaire: Ledil Oy C10710_Cute-3-O-Plus-S C10710_Cute-3-O-Plus-S
Lamps: 3 x Osram-os Golden Dragon+

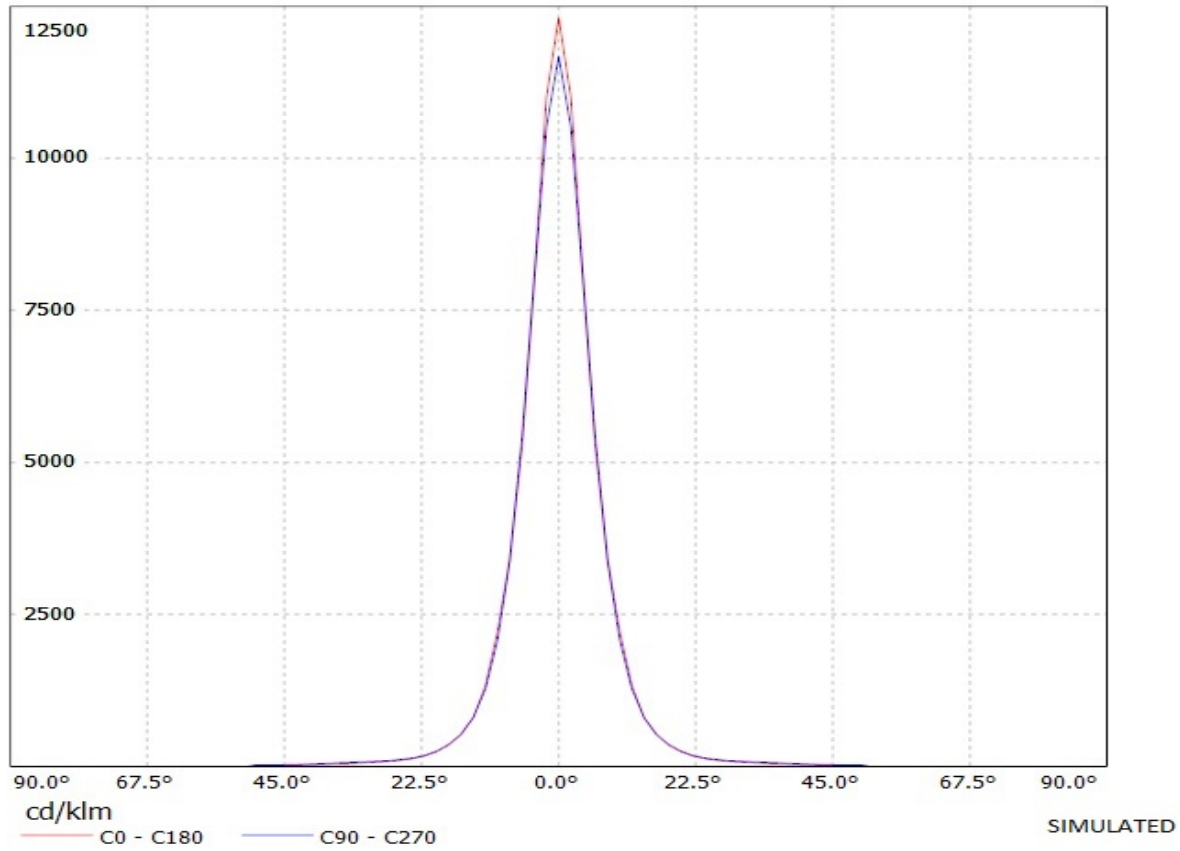

Ledil Oy C10711_Cute-3-O-Plus-M C10711_Cute-3-O-Plus-M / LDC (Linear)

Luminaire: Ledil Oy C10711_Cute-3-O-Plus-M C10711_Cute-3-O-Plus-M

Lamps: 3 x Osram-os Golden Dragon+

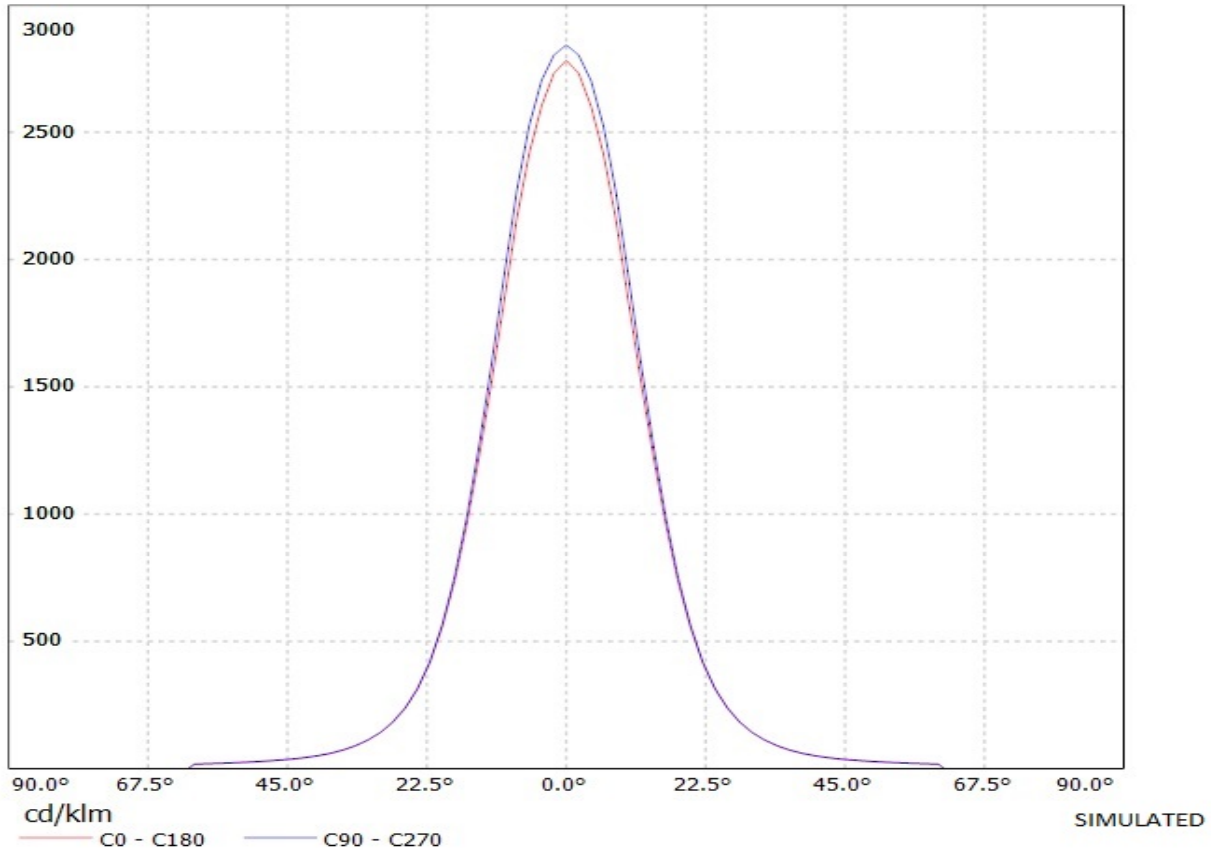

Ledil Oy C10712_Cute-3-O-Plus-W C10712_Cute-3-O-Plus-W / LDC (Linear)

Luminaire: Ledil Oy C10712_Cute-3-O-Plus-W C10712_Cute-3-O-Plus-W
Lamps: 3 x Osram-os Golden Dragon+

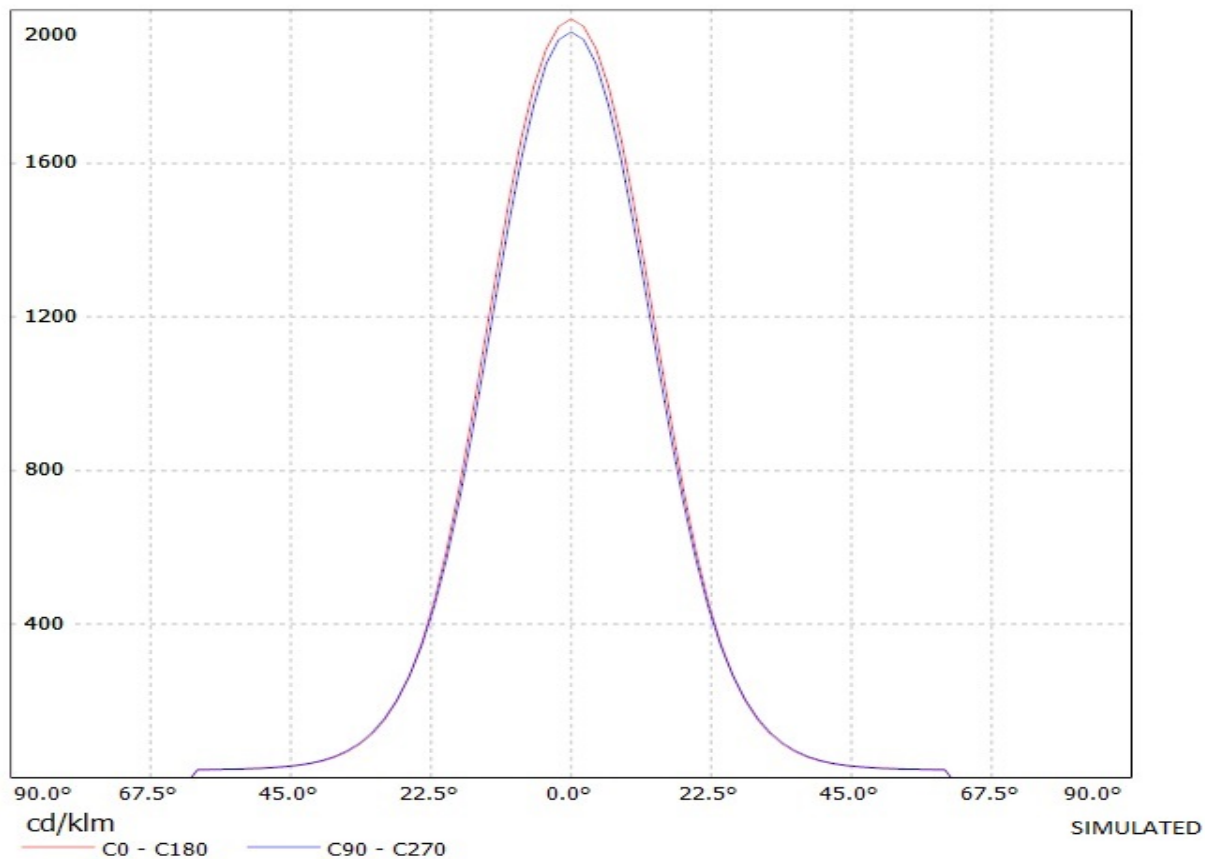

Ledil Oy C10710_Cute-3-O-Plus-S C10710_Cute-3-O-Plus-S / LDC (Polar)

Luminaire: Ledil Oy C10710_Cute-3-O-Plus-S C10710_Cute-3-O-Plus-S

Lamps: 3 x Osram-os Golden Dragon+

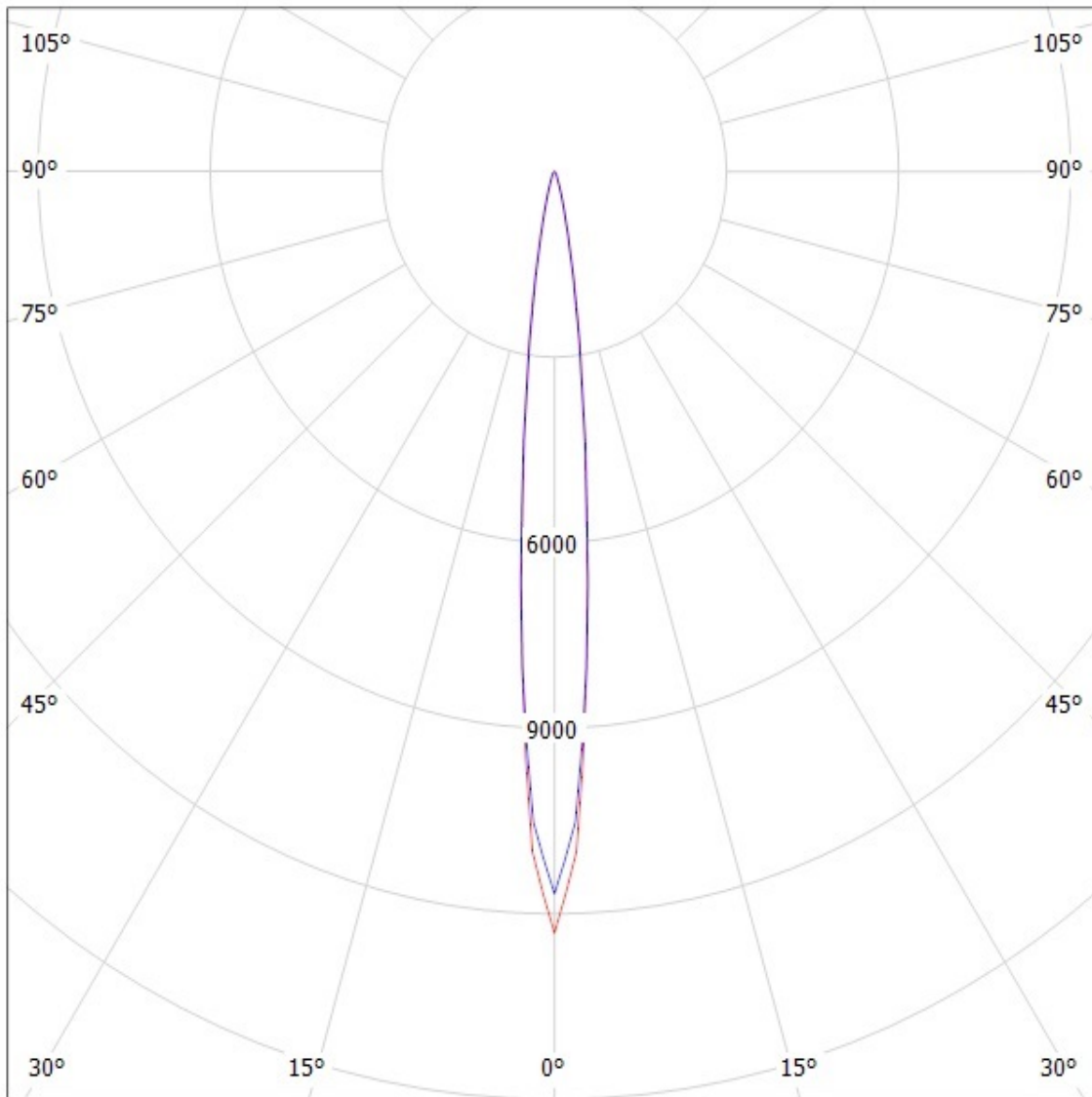

cd/klm

— C0 - C180 — C90 - C270

SIMULATED

Ledil Oy C10711_Cute-3-O-Plus-M C10711_Cute-3-O-Plus-M / LDC (Polar)

Luminaire: Ledil Oy C10711_Cute-3-O-Plus-M C10711_Cute-3-O-Plus-M

Lamps: 3 x Osram-os Golden Dragon+

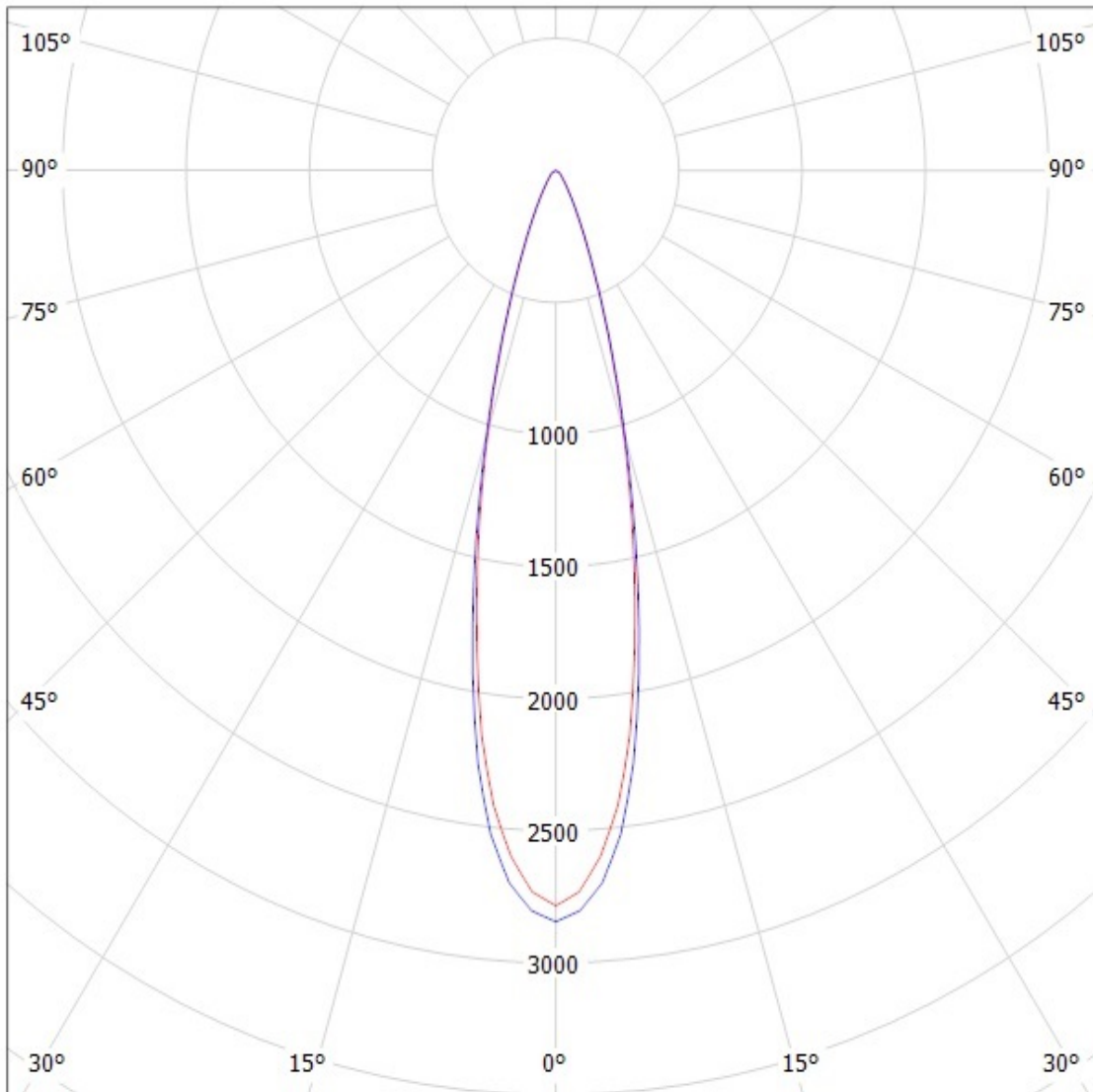

cd/klm

— C0 - C180 — C90 - C270

SIMULATED

Ledil Oy C10712_Cute-3-O-Plus-W C10712_Cute-3-O-Plus-W / LDC (Polar)

Luminaire: Ledil Oy C10712_Cute-3-O-Plus-W C10712_Cute-3-O-Plus-W

Lamps: 3 x Osram-os Golden Dragon+

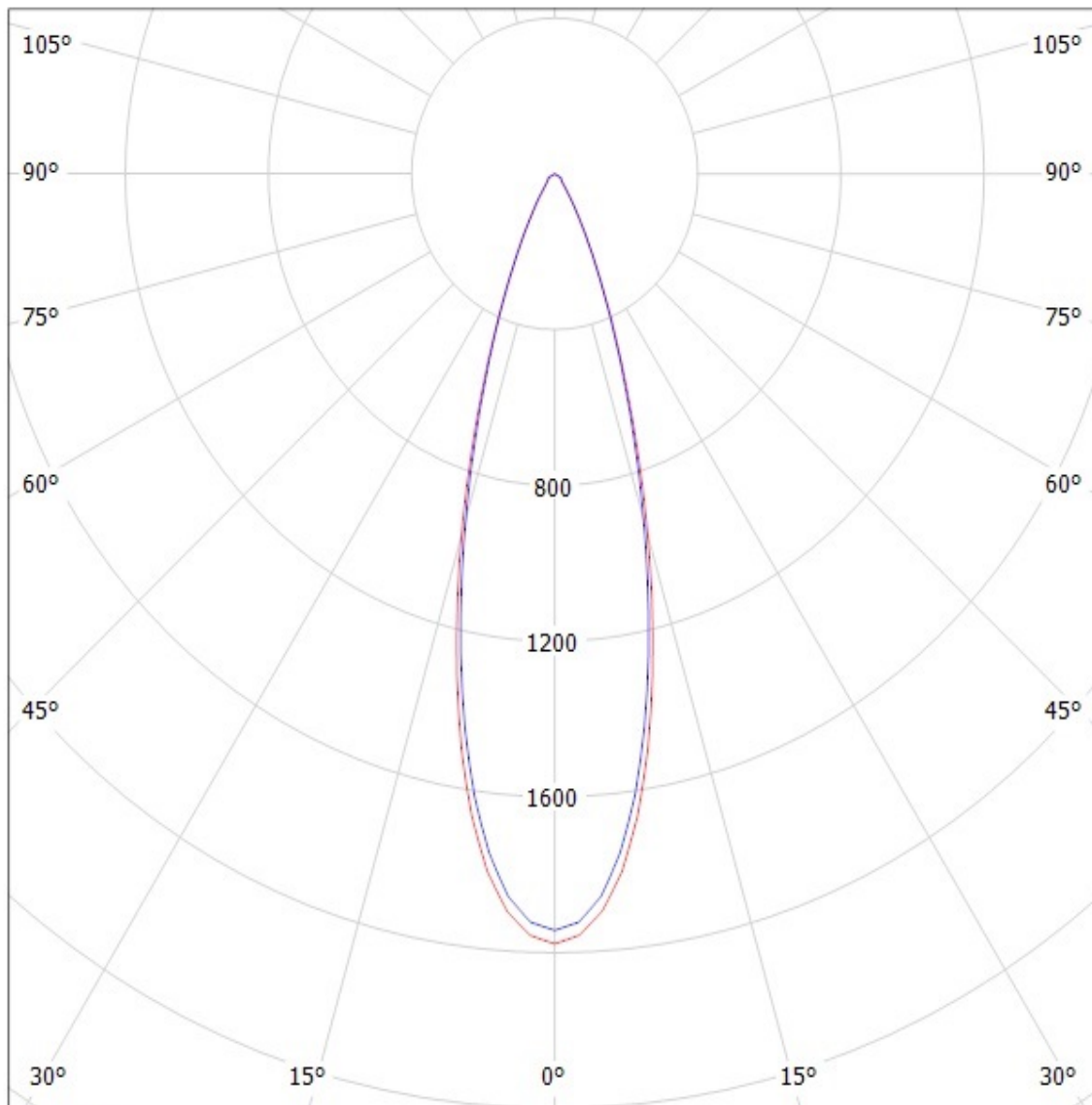

cd/klm

— C0 - C180 — C90 - C270

SIMULATED