

○ New Product Information

[□BACK](#)

Compact Transmissive-type Photointerrupter



GP1S396HCPSF/GP1S396HCP0F

Package technology that enables products to maintain optical characteristics and reliable performance, and to achieve compact form.

A lineup of compact and low-profile transmissive types with high detection accuracy.

■ Features

- More compact, lower profile
More compact size (1.6 mm low profile) than conventional model has been achieved along with widening of gap to 1.2 mm
The optimal device for development of compact lens units
- Improved detection accuracy
Achieves high detection accuracy with a narrow slit width (0.12 mm)
Compatible with even higher-precision lens units
- Reduced design restrictions
- Using know-how related to assembly of light-emitting and light-receiving elements, SHARP has achieved a photocurrent MIN./MAX. variability ratio of 4
- Surface-mount type (GP1S396HCPSF) and boardinsertion type (GP1S396HCP0F) enables various types of mounting
- Halogen-free

Conventional model:
GP1S296HCPSF

Size: $2.5 \times 1.8 \times 1.9$ mm
Gap width: 1.0 mm
Slit width: 0.2 mm

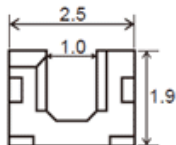

More compact

Volume:
41% reduced from the conventional model
Height:
16% reduced from the conventional model

New product:
GP1S396HCPSF

Size: $2.26 \times 1.4 \times 1.6$ mm
Gap width: 1.2 mm
Slit width: 0.12 mm

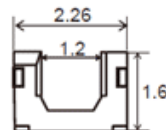

Gap width: 0.2 mm wider
Slit width: 0.08 mm narrower

■ Outline Dimensions

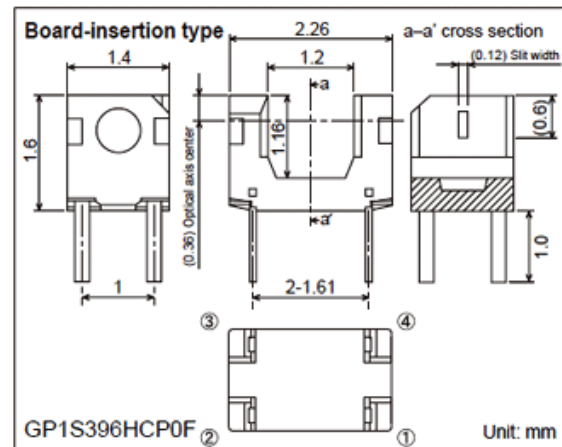
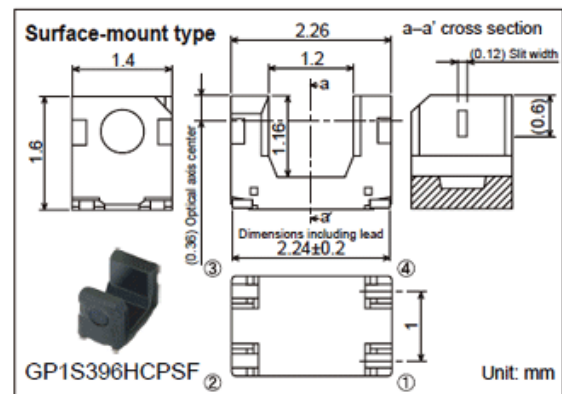

Internal connection diagram

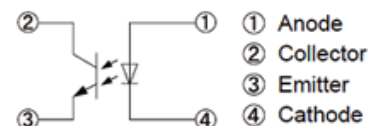

■Main Specifications

(Ta = 25 °C)

Item	Symbol	Specifications	Conditions
Forward voltage	V _F	MAX. 1.4 V	I _F = 20 mA
Dark current	I _{CEO}	MAX. 100nA	V _{CE} = 20 V
Photocurrent	I _C	100 to 400 μA	V _{CE} = 5 V, I _F = 5 mA
Collector-emitter saturation voltage	V _{CE(sat)}	MAX. 0.4 V	I _F = 10 mA, I _C = 40 μA
Operating temperature	T _{opr}	-25 to +85 °C	-

■Application Examples

- Digital camera / mobile phone with camera
- AV equipment (BD recorder/DVC)
- OA Equipment (BD pickup)

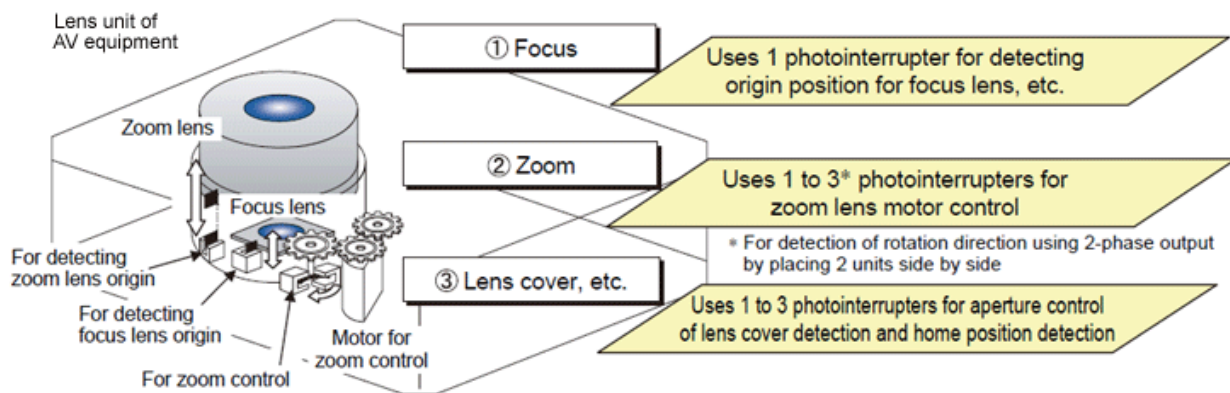

Digital camera ①②③

Mechanism example for camera's lens unit

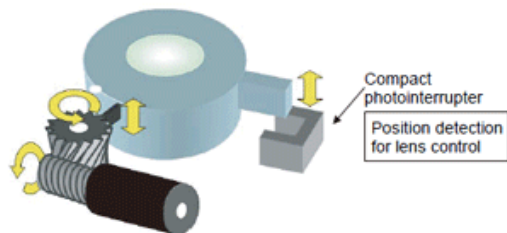

Blu-ray drive ①

Mechanism example for optical disc pickup

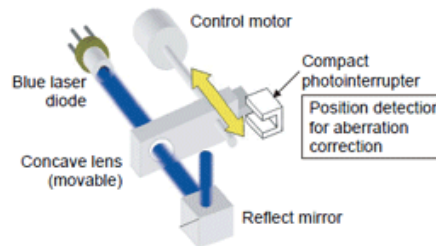

[Back to top](#)

