

Industrial Ethernet to Fiber Repeater
EF24 Series

Hardware Installation Guide
Version 1.1
Updated in July, 2015



Installation Overview

The device's appearance is as in the figure below.

1. If you have purchased the wall mount kit, proceed to place the screws on the back of the device as show in (Fig. 1).

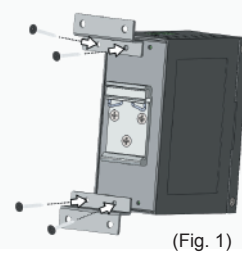

2. Although internal grounding has been done inside, in order to ensure overall maximum performance and protect your device, it is still strongly advised to ground the device properly; hazardous ESD can come into contact and damage your equipment. On the power terminal block, there is a terminal for Frame Ground, you can choose whether to connect it to the grounding or you may opt to connect it to the grounding screw next to the terminal block (the one chosen should be connected at all times) (Fig. 2)

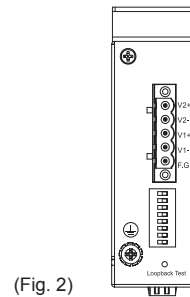

3. You can then choose whether to plug in the other peripheral ports at this point or do it later depending on the actual location of the device or level of comfort for performing such operation.

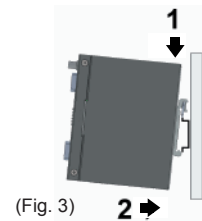

4. Once the plate has been firmly put in place, proceed to mount the whole device as shown in (Fig. 3). Proceed to (Fig. 4) if you want to remove the device from DIN-Rail.

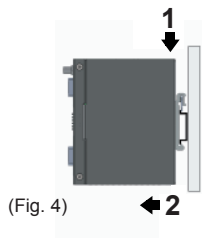

5. Next we can then proceed to connect the device to the LAN (switch or PC, depending on the case), take care on using the RJ-45 connector; after this we can then proceed to the device's settings

- The openings to the sides are for the device's heat dissipation, please never obstruct or cover them with any objects or try to insert any objects through them.

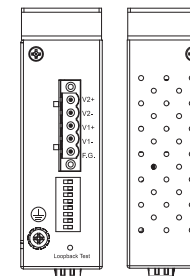

Package Check List

Inside the package you will find the following items:

- Industrial Ethernet to Fiber Repeater x 1
- 5-Pin 5.08mm Lockable Terminal Block (Already mounted to the device) x 1
- DIN-Rail Kit (Already mounted to the device) x 1
- SFP Protective caps x 2 (For SFP model only)
- Installation Guide with Warranty Card x 1



Never install or work on electrical or cabling during periods of lightning activity. Never connect or disconnect power when hazardous gases are present.



Caution: CLASS 1 LASER PRODUCT. Do not stare into the laser!



Warning: Hot Surface Do Not Touch. RESTRICTED ACCESS AREA: The equipment should only be installed in a Restricted Access Area.

Product Layout

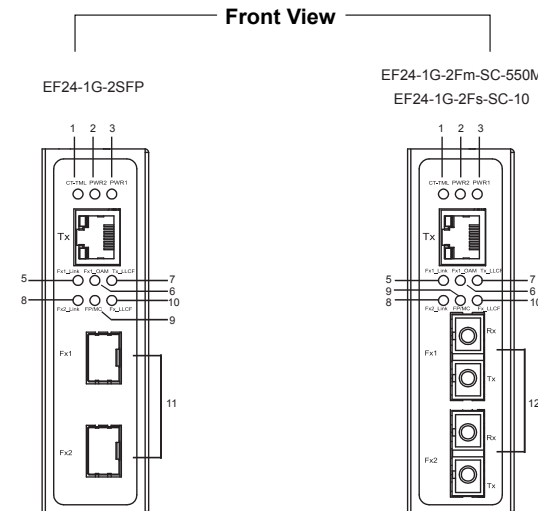

- 1. CT-TML LED
- 2. PWR2 LED
- 3. PWR1 LED
- 4. 10/100/1000 Base-T(X) RJ-45 Port
- 5. Fx1_Link LED
- 6. Fx1_OAM LED
- 7. Tx_LLCF LED
- 8. Fx2_Link LED
- 9. FP/MC LED
- 10. Fx_LLCF LED
- 11. 100 Base-FX or 1000 Base-X SFP Slots
- 12. 100/1000 Base-X SC connectors

Top View

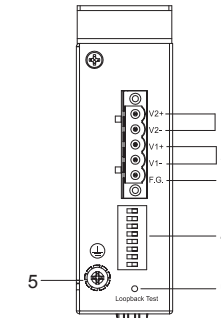

- 1. Terminal for PWR2
- 2. Terminal for PWR1
- 3. Frame Ground
- 4. DIP Switches
- 5. Grounding Screw
- 6. Loopback test Button

100 Base-FX or 1000 Base-X Fiber Optics SFP Slot

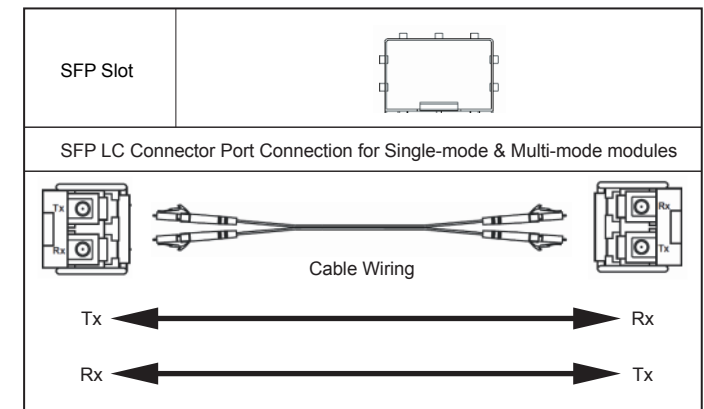

Caution
The SFP slot should be used in conjunction with a MSA compliant optical transceiver.

1000 Base-SX / LX Fiber Port

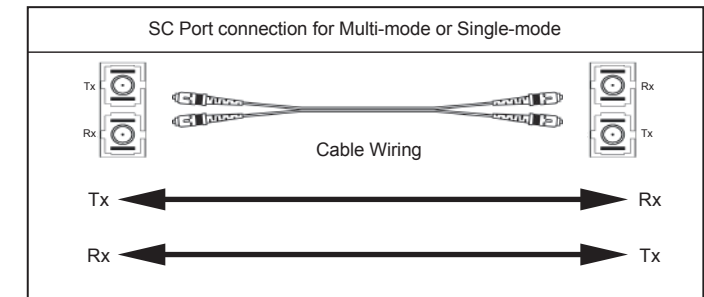

Cable Type
Multi-mode : 50/125µm or 62.5/125µm fiber patch cord cable
Single-mode : 9/125µm fiber patch cord cable

DIP Switch

Pin	Mode	OFF	ON
1	Function Mode	Media Converter	Repeater
2	Fiber Speed	1000Base-X	100Base-FX
3	Link Transparency	Disable	Enable
4	Terminal/ Center mode	Terminal	Center
5	Power Save Mode	Disable	Enable
6	Fiber Auto Negotiation	Enable	Disable
7	Jumbo Frame (9KB)	Disable	Enable
8	Cut-Through Mode	Disable	Enable

Note: The device will read the DIP switch values only at the device's initialization time. Please ensure to power OFF and power ON the device to allow the new DIP switch values to take effect.

LED Indicators

LED	Color	Status	Description
PWR1	Green	ON	Power is being supplied through this power input
PWR2		OFF	Power is not supplied through this power input
CT-TML	Green	ON	The device operates as a center media converter
		OFF	The device operates as a terminal media converter
FP/MC	Green	ON	Fiber repeater mode
		OFF	Media converter mode
Fx1_Link	Green	ON	The link is connected and no traffic is detected
Fx2_Link		OFF	The link is disconnected
Fx2_Link		Blinking	Data is transmitting or receiving
Fx1_OAM	Green	ON	The test passed (LED ON after testing for 3 seconds)
		OFF	The test failed (LED OFF after testing for 3 seconds)
		Blinking	The loopback test is in progress
Fx_LLCF	RED	ON	The Fiber/Copper port is forced to link down by LLCF
Tx_LLCF		OFF	The Fiber/Copper port is not forced to link down by LLCF
TX_Link/Act	Green	ON	The link is connected and no traffic is detected
		Blinking	Data is transmitting or receiving
TX_Speed	Yellow	ON	The link is connected at 1000 Mbps.
		OFF	The link is connected at 10 or 100 Mbps if TX_Link/Act is ON or blinking

Unit Dimensions and Layout (unit=mm)

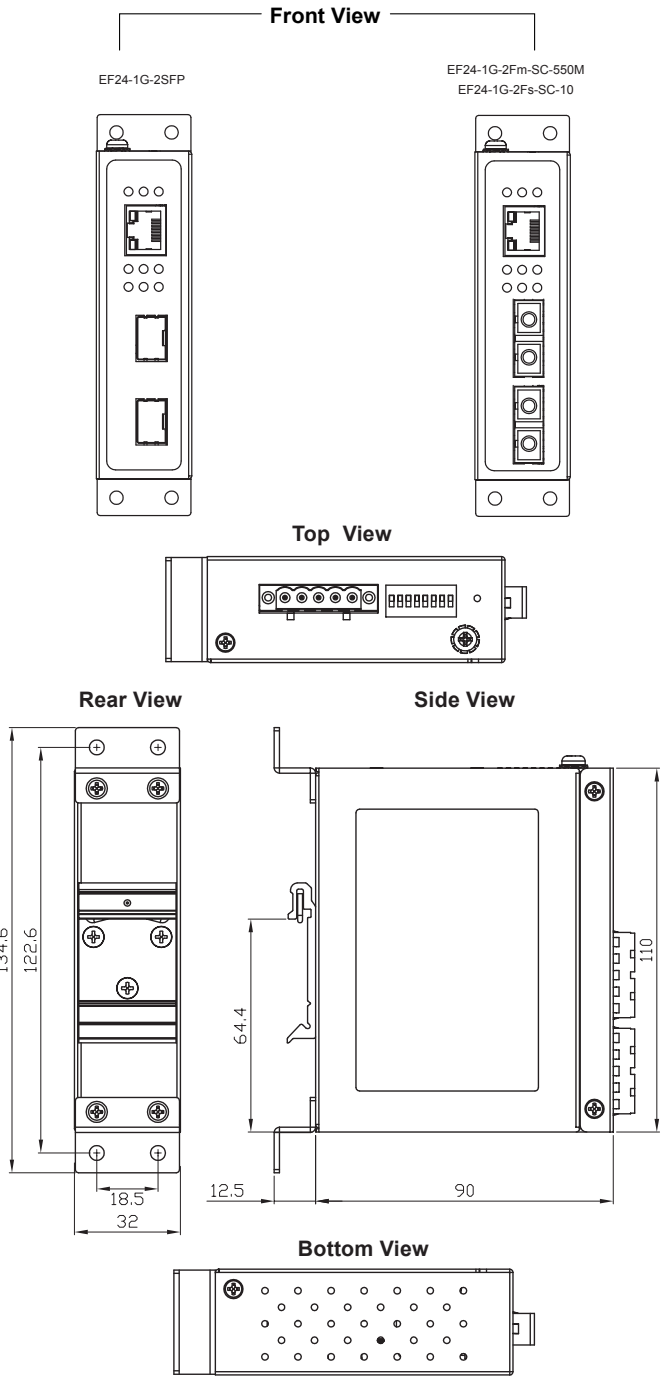

※ The wall mount kit illustrated in this document is for reference only and is not included in the package.

Field Maintenance and Service

- If the device requires servicing of any kind, you may need to disconnect and remove it from its mounting. The initial installation should be done in a way that makes this as convenient as possible.
- Voltage/Power lines should be properly insulated as well as other cables. Be careful when handling the so as to not trip over
- Do not under any circumstance insert foreign objects of any kind into the heat dissipation holes located in the different faces of the device. This may not only harm the internal layout but might cause harm to you as well.
- Don not under any circumstance open the device for any reason. Please contact your dealer for any repair needed or follow the instructions on section of your User's Manual.

Warranty Policy

Warranty Conditions

Products supplied by Atop Technologies are covered in this warranty for sub-standard performance or defective workmanship. The warranty is not, however, extended to goods damaged in the following circumstances:

- Excessive forces or impacts
- War or an Act of God: wind storm, fire, flood, electric shock, earthquake
- Use of unqualified power supply, connectors, or unauthorized parts/kits
- Replacement with unauthorized parts

RMA and Shipping Costs Reimbursement

Customers shall always obtain an authorized "RMA" number from Atop before shipping the goods to be repaired to Atop. When in normal use, a sold product shall be replaced with a new one within 3 months after purchase. The shipping cost from the customer to Atop will be reimbursed by Atop.

After 3 months and still within the warranty period, it is up to Atop whether to replace the unit with a new one; normally, as long as a product is under warranty, all parts and labor are free of charge to the customers.

After the warranty period, the customer shall cover the cost for parts and labor. Three months after purchase, the shipping cost from the customer to Atop will not be reimbursed, but the shipping cost from Atop to the customer will be paid by Atop.

Limited Liability

Atop shall not be held responsible for any consequential losses from using Atop's product.

Warranty Period

Product Categories	Warranty
Ethernet Switches	5 Years
Wireless	
Serial Device Servers	
Modbus Gateways	
Embedded Device Servers	
Media Converters	3 Years
DIN-Rail Power Supplies	
Power Adaptors	1 Year
Antennas	
Other Accessories	

The warranty certification will not be effective until an authorized stamp issued by Atop's overseas agents.

Purchase Date: / / (yyyy/mm/dd)

Serial Number



Atop Customer Services and Supports

- Please contact your local dealers or Atop Technical Support Center at the following numbers.
 - + 886-3-550-8137 (Atop Taiwan)
 - + 86-21-6495-6232 (Atop China)
- Please report the defected problems via Atop's Web site or E-mail account
 - Web Site : www.atop.com.tw, e-mail : service@atop.com.tw
 - Web Site : www.atop.com.cn, e-mail : service@atop.com.cn