

OS Series Miniature Slide Switches

Features/Benefits

- Variety of actuators & terminations
- PC and panel mounting
- Shorting or non-shorting contacts
- RoHS compliant
- Halogen free material

Typical Applications

- Test & measurement equipment
- Computer peripherals & network products
- Consumer products



Specifications

CONTACT RATING: See individual parts.
 MECHANICAL & ELECTRICAL LIFE: 10,000 cycles.
 CONTACT RESISTANCE: 20 mΩ or less.
 INSULATION RESISTANCE: 100 MΩ min. at 500 VDC.
 DIELECTRIC STRENGTH: 500 VAC for 1 minute.
 OPERATING TEMPERATURE: -30°C to +70°C.
 PACKAGING: Bulk

* For RoHS compatible switches contact customer service.

Materials

BASE: Phenolic resin.
 ACTUATOR: POM, black.
 HOUSING PLATE: Non-compatible; SPCC Sn plated.
 Compatible; SPCC Ni plated.
 MOVABLE CONTACT: Copper alloy, silver plated.
 STATIONARY CONTACTS: Brass, silver plated.
 TERMINALS: Brass, silver plated.
 TERMINAL SEALED.

NOTE: Specifications and materials listed above are for switches with standard options. For information on specific and custom switches, consult Customer Service Center.

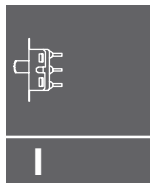

Slide

How To Order

Complete part numbers for OS Series Slide Switches are shown on pages I-37 through I-43.

PART NUMBER			SWITCH FUNCTION	
	RoHS Compliant	RoHS Compatible	POS.1	POS.2
OS102011MS2QN1 (non-shorting)	YES	NO	ON	ON
OS102011MS2QN1C* (non-shorting)	YES	YES	ON	ON
OS102011MS2QS1 (shorting)	YES	NO	ON	ON
OS102011MS2QS1C* (shorting)	YES	YES	ON	ON
CONN. TERMINALS			1-2	2-3
SCHEMATIC				
SPDT				

CONTACT RATING: 0.1A @ 12 VDC

* "C" option at the end of part number designates high temperature actuators

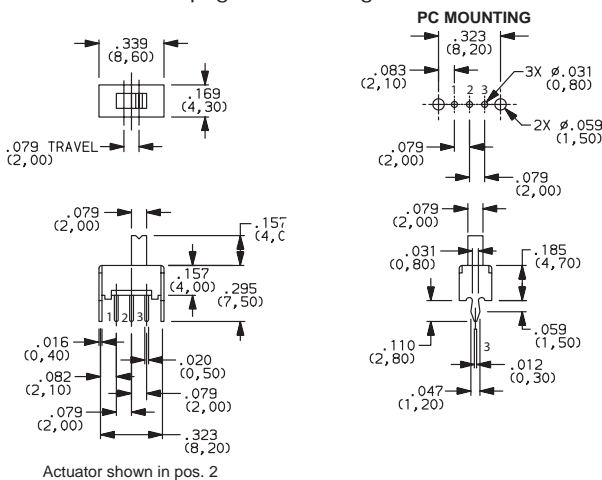

PART NUMBER			SWITCH FUNCTION		
	ROHS Compliant	ROHS Compatible	POS.1	POS.2	POS.3
OS103011MS8QP1 (Non-specified)	YES	NO	ON	ON	ON
OS103011MS8QP1C* (Non-specified)	YES	YES	ON	ON	ON
CONN. TERMINALS			1-2	2-3	2-4
SCHEMATIC					
SP3T					

CONTACT RATING: 0.1A @ 12 VDC

* "C" option at the end of part number designates high temperature actuators

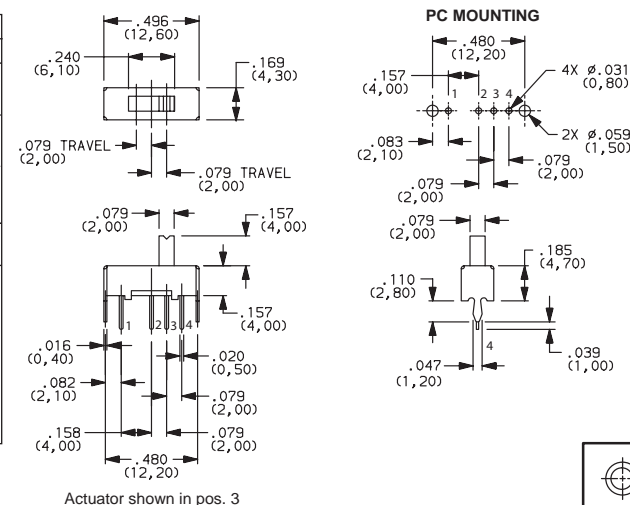

Dimensions are shown: Inches (mm)
 Specifications and dimensions subject to change



9 nov 16

OS Series Miniature Slide Switches



OS202011MS2QS1
DPDT

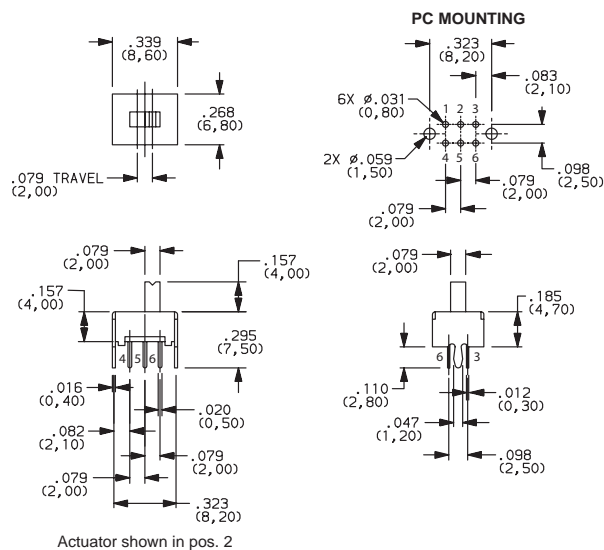

PART NUMBER	RoHS Compliant	RoHS Compatible	SWITCH FUNCTION	
			POS.1	POS.2
OS202011MS2QS1 (Shorting)	YES	NO	ON	ON
OS202011MS2QN1 (Non-shorting)	YES	NO	ON	ON
CONN. TERMINALS			1-2, 4-5	2-3, 5-6
SCHEMATIC				

CONTACT RATING: 0.1A @ 12 VDC



OS203011MS1QP1
DP3T

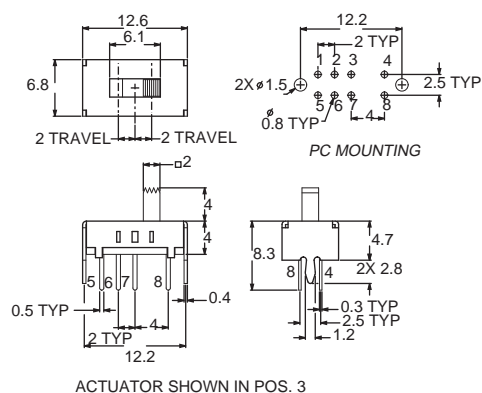

PART NUMBER	ROHS Compliant	ROHS Compatible	SWITCH FUNCTION		
			POS.1	POS.2	POS.3
OS203011MS1QP1 (Non-specified)	YES	NO	ON	ON	ON
CONN. TERMINALS			1-3, 5-7	2-3, 6-7	3-4, 7-8
SCHEMATIC					

CONTACT RATING: 0.3A @ 30 VDC



OS202013MT5QN1
DPDT

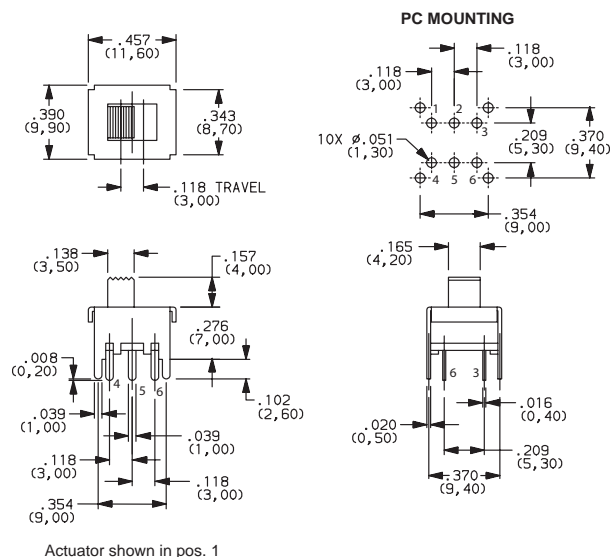

PART NUMBER	RoHS Compliant	RoHS Compatible	SWITCH FUNCTION	
			POS.1	POS.2
OS202013MT5QN1 (Non-shorting)	YES	NO	ON	ON
CONN. TERMINALS			1-2, 4-5	2-3, 5-6
SCHEMATIC				

CONTACT RATING: 0.3A @ 30 VDC

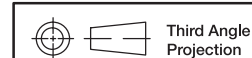

Dimensions are shown: Inch (mm)
Specifications and dimensions subject to change



OS Series Miniature Slide Switches

PART NUMBER	ROHS		SWITCH FUNCTION		
	Compliant	Compatible	POS.1	POS.2	POS.3
OS203013MT7QN1 (Non-shorting)	YES	NO	ON	OFF	ON
CONN. TERMINALS			1-2, 4-5		2-3, 5-6
SCHEMATIC					
DP3T					

CONTACT RATING: 0.3A @ 30 VDC

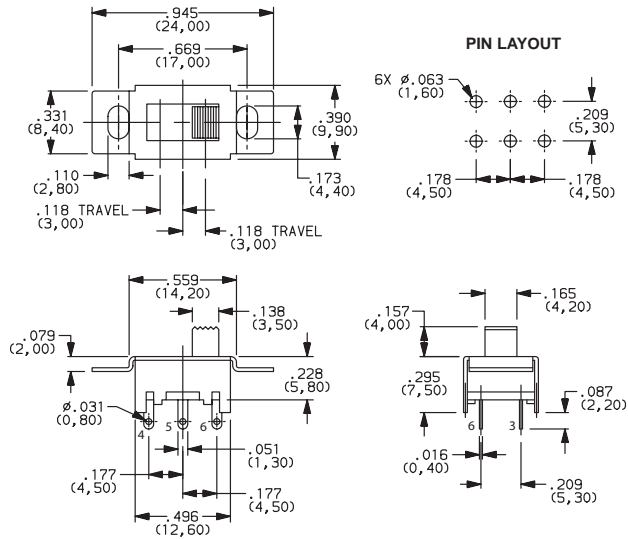

OS203013MT7QN1
DP3T

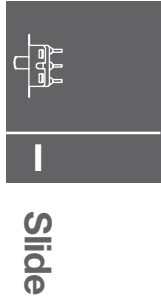

PART NUMBER	ROHS		SWITCH FUNCTION	
	Compliant	Compatible	POS.1	POS.2
OS202013MT8QN1 (Non-shorting)	YES	NO	ON	ON
CONN. TERMINALS			1-2, 4-5	2-3, 5-6
SCHEMATIC				
DPDT				

CONTACT RATING: 0.3A @ 30 VDC

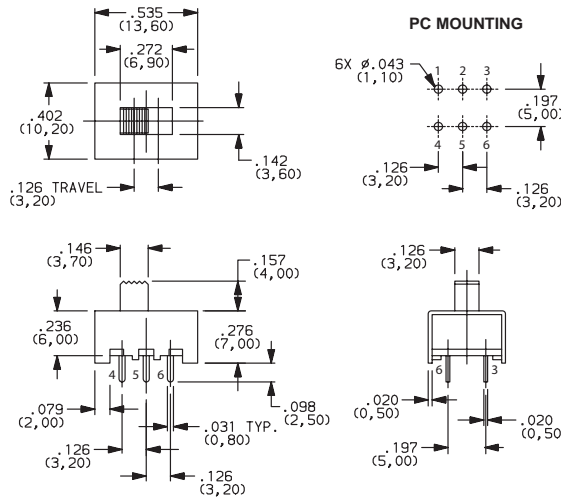

OS202013MT8QN1
DPDT

PART NUMBER	ROHS		SWITCH FUNCTION		
	Compliant	Compatible	POS.1	POS.2	POS.3
OS203013MT8QN1 (Non-shorting)	YES	NO	ON	ON	ON
CONN. TERMINALS			1-2, 5-6	2-3, 6-7	3-4, 7-8
SCHEMATIC					
DP3T					

CONTACT RATING: 0.3A @ 30 VDC

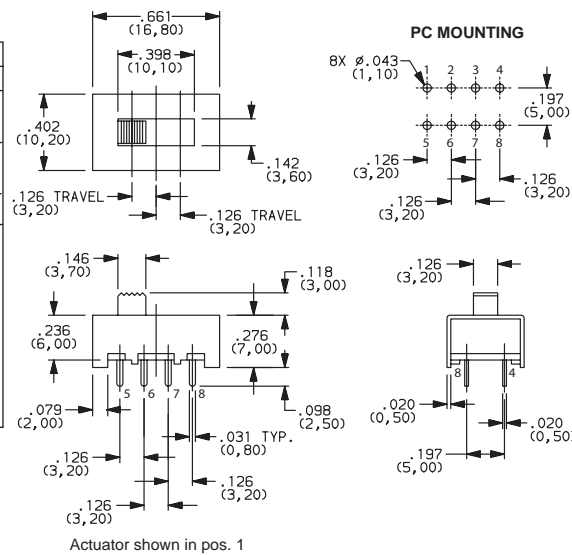

OS203013MT8QN1
DP3T

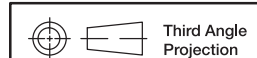

Dimensions are shown: Inches (mm)
Specifications and dimensions subject to change



9 nov 16

OS Series Miniature Slide Switches



OS203013MT6QN1
DP3T

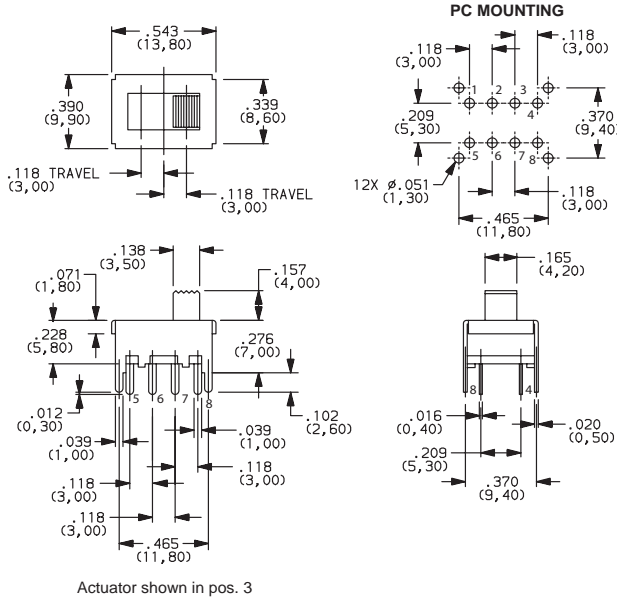

PART NUMBER	ROHS Compliant	ROHS Compatible	SWITCH FUNCTION		
			POS.1	POS.2	POS.3
OS203013MT6QN1 (Non-shorting)	YES	NO	ON	ON	ON
CONN. TERMINALS			1-2, 5-6	2-3, 6-7	3-4, 7-8
SCHEMATIC					

CONTACT RATING: 0.2A @ 30 VDC



OS103012MU1QP1
SP3T

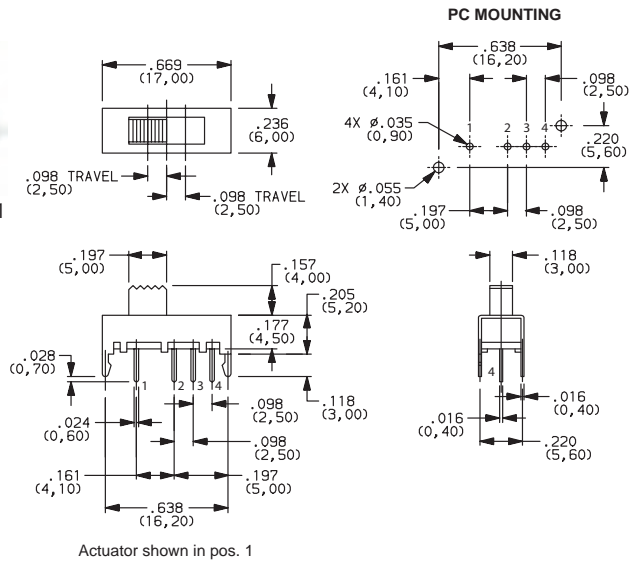

PART NUMBER	ROHS Compliant	ROHS Compatible	SWITCH FUNCTION		
			POS.1	POS.2	POS.3
OS103012MU1QP1 (Non-shorting)	YES	NO	ON	ON	ON
CONN. TERMINALS			1-2	2-3	2-4
SCHEMATIC					

CONTACT RATING: 0.2A @ 30 VDC



OS103012MU2QP1
SP3T

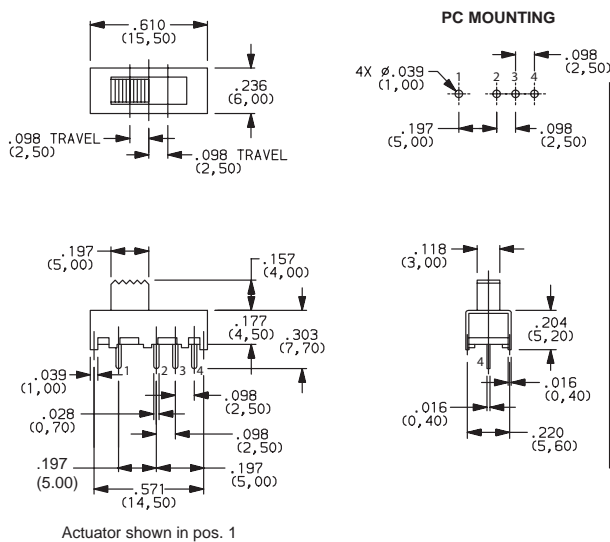

PART NUMBER	ROHS Compliant	ROHS Compatible	SWITCH FUNCTION		
			POS.1	POS.2	POS.3
OS103012MU2QP1 (Non-shorting)	YES	NO	ON	ON	ON
CONN. TERMINALS			1-2	2-3	2-4
SCHEMATIC					

CONTACT RATING: 0.2A @ 30 VDC

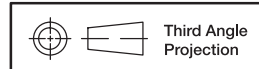

Dimensions are shown: Inch (mm)
Specifications and dimensions subject to change



Slide

OS Series Miniature Slide Switches

PART NUMBER	ROHS Compliant	ROHS Compatible	SWITCH FUNCTION		
			POS.1	POS.2	POS.3
OS203012MU5QP1 (Non-specified)	YES	NO	ON	ON	ON
CONN. TERMINALS			1-2, 5-6	2-3, 6-7	2-4, 6-8
SCHEMATIC					
DP3T					

CONTACT RATING: 0.1A @ 30 VDC

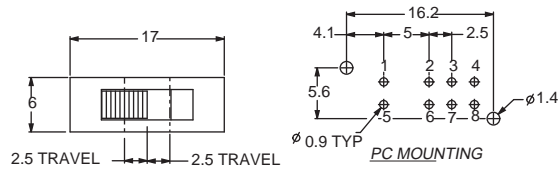

OS203012MU5QP1
DP3T

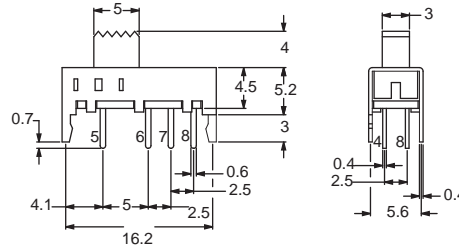

ACTUATOR SHOWN IN POS. 1

PART NUMBER	RoHS Compliant	RoHS Compatible	SWITCH FUNCTION	
			POS.1	POS.2
OS202011MV4QN1 (Non-shorting)	YES	NO	ON	ON
OS202011MV4QS1 (Shorting)	YES	NO	ON	ON
CONN. TERMINALS			1-2, 4-5	2-3, 5-6
SCHEMATIC				
DPDT				

CONTACT RATING: 0.1A @ 30 VDC

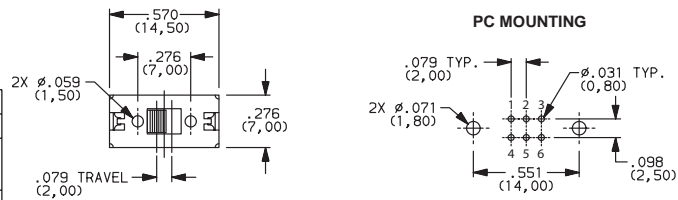

OS202011MV4QN1
DPDT

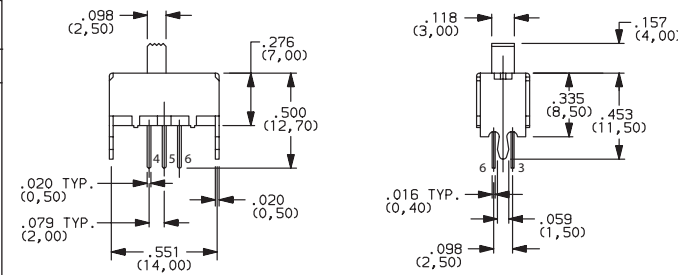

Actuator shown in pos. 1

PART NUMBER	ROHS Compliant	ROHS Compatible	SWITCH FUNCTION		
			POS.1	POS.2	POS.3
OS203011MV9QS1 (Shorting)	YES	NO	ON	ON	ON
OS203011MV9QN1 (Non-Shorting)	YES	NO	ON	ON	ON
CONN. TERMINALS			1-2-5 6-7-10	1-3-5 6-8-10	1-4-5 6-9-10
SCHEMATIC					
DP3T					

CONTACT RATING: 0.1A @ 30 VDC

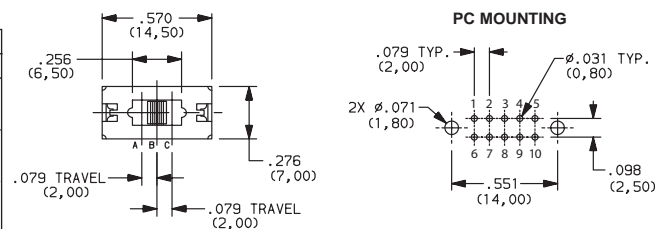

OS203011MV9QS1
DP3T

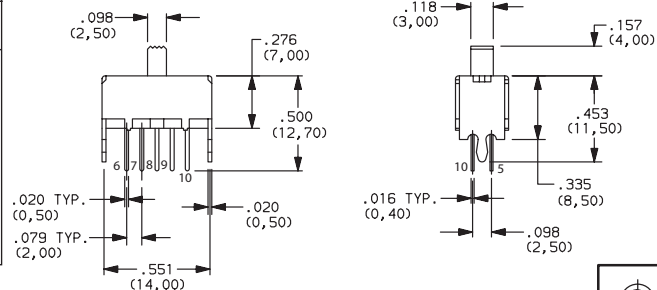

Actuator shown in pos. 2(A)



Third Angle Projection

Dimensions are shown: Inches (mm)
Specifications and dimensions subject to change



9 nov 16



OS Series Miniature Slide Switches



OS102011MA1QN1
SPDT

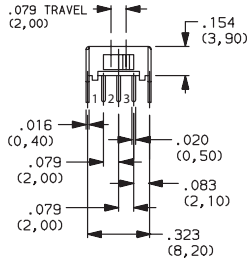
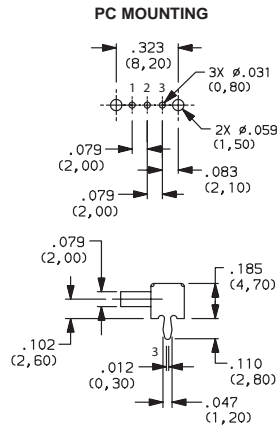
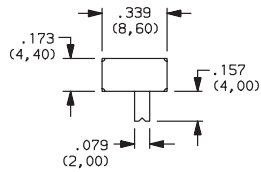

Actuator shown in pos. 2

PART NUMBER	SWITCH FUNCTION		POS.1	POS.2
	RoHS Compliant	RoHS Compatible		
OS102011MA1QN1 (Non-shorting)	YES	NO	ON	ON
OS102011MA1QN1C* (Non-shorting)	YES	YES	ON	ON
OS102011MA1QS1 (Shorting)	YES	NO	ON	ON
OS102011MA1QS1C* (Shorting)	YES	YES	ON	ON
CONN. TERMINALS			1-2	2-3
SCHEMATIC				
<p>SPDT</p>				

CONTACT RATING: 0.1A @ 12 VDC

* "C" option at the end of part number designates high temperature actuators



OS103011MA7QP1
SP3T

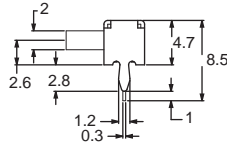
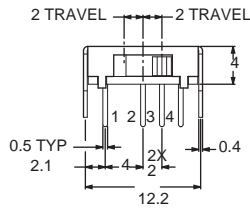
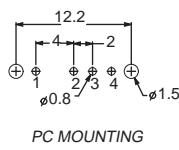
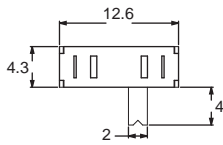

PART NUMBER	SWITCH FUNCTION				
	ROHS Compliant	ROHS Compatible	POS.1	POS.2	POS.3
OS103011MA7QP1 (Non-specified)	YES	NO	ON	ON	ON
OS103011MA7QP1C* (Non-specified)	YES	YES	ON	ON	ON
CONN. TERMINALS			1-2	2-3	2-4
SCHEMATIC					
<p>SP3T</p>					

CONTACT RATING: 0.1A @ 12 VDC

* "C" option at the end of part number designates high temperature actuators



OS203011MA2QP1
DP3T

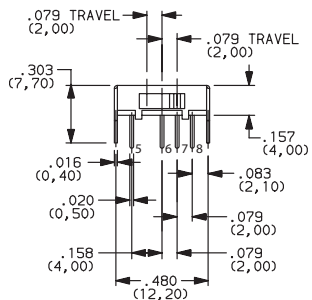
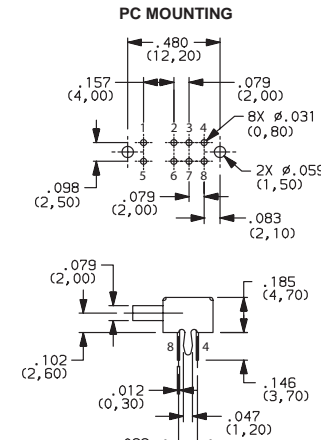
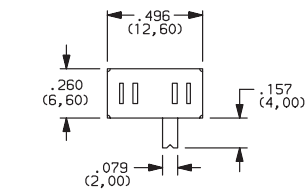

Actuator shown in pos. 3

PART NUMBER	SWITCH FUNCTION				
	ROHS Compliant	ROHS Compatible	POS.1	POS.2	POS.3
OS203011MA2QP1 (Non-specified)	YES	NO	ON	ON	ON
CONN. TERMINALS			1-2, 5-6	2-3, 6-7	2-4, 6-8
SCHEMATIC					
<p>DP3T</p>					

CONTACT RATING: 0.1A @ 12 VDC

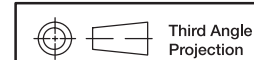

Dimensions are shown: Inch (mm)
Specifications and dimensions subject to change



OS Series Miniature Slide Switches

PART NUMBER	RoHS Compliant	RoHS Compatible	SWITCH FUNCTION	
			POS.1	POS.2
OS202011MA0QN1 (Non-shorting)	YES	NO	ON	ON
OS202011MA0QS1 (Shorting)	YES	NO	ON	ON
CONN. TERMINALS			1-2, 4-5	2-3, 5-6
SCHEMATIC				
DPDT				

CONTACT RATING: 0.1A @ 12 VDC

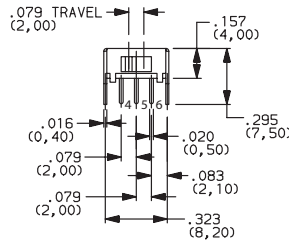
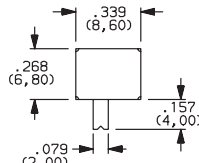

Actuator shown in pos. 1

PC MOUNTING

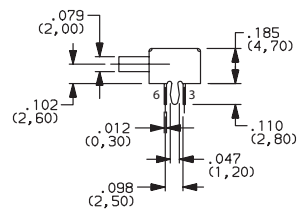
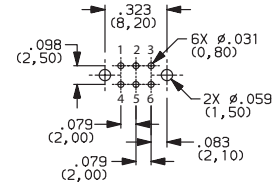

OS202011MA0QN1
DPDT

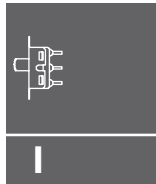

Slide